



PRINTING INSTRUCTION

1. File > Print
2. Click on “Page Setup” button make sure your paper size is set to the paper size that you will print and Scale at 100%
3. In “Pages Sizing & Handling” click on “Size” button and select “Actual size”

The image shows two screenshots of software dialog boxes. The left screenshot is the 'Print' dialog box. A red callout box labeled 'Select Actual size' points to the 'Actual size' radio button in the 'Page Sizing & Handling' section. Another red callout box labeled 'Set the paper size' points to the 'Page Setup...' button at the bottom left. The right screenshot is the 'Page Setup' dialog box. A red callout box labeled 'Select the paper size' points to the 'Paper Size' dropdown menu, which is set to 'A4'. Another red callout box labeled 'Scale 100%' points to the 'Scale' input field, which is set to '100'.

IMPORTANT NOTE:

- **ADOBE ACROBAT READER (FREE SOFTWARE)** is recommended to open and print the patterns

link for free download

<https://get.adobe.com/reader>

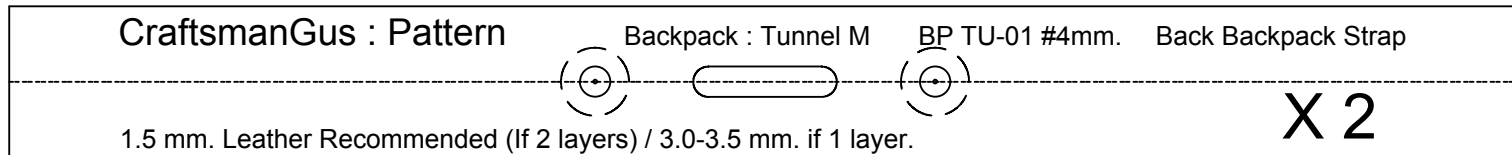
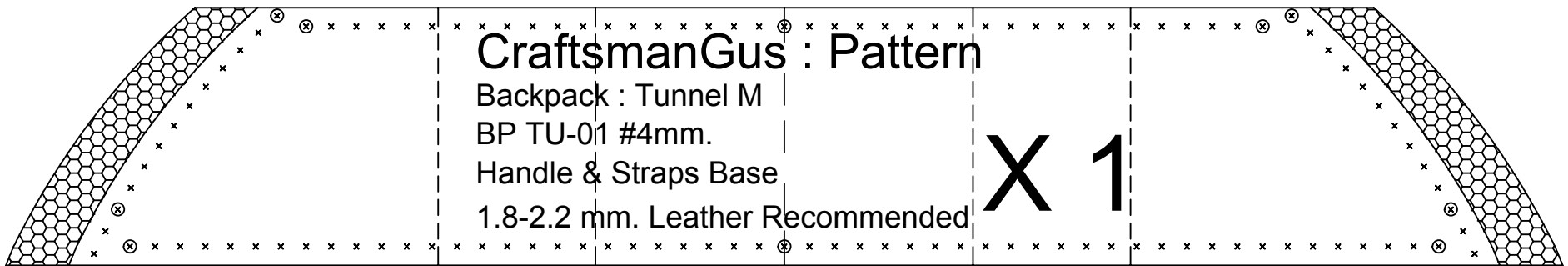
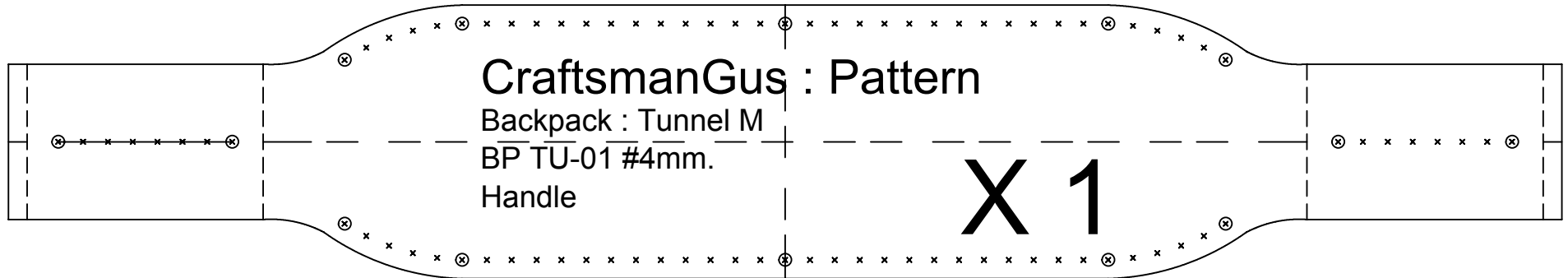

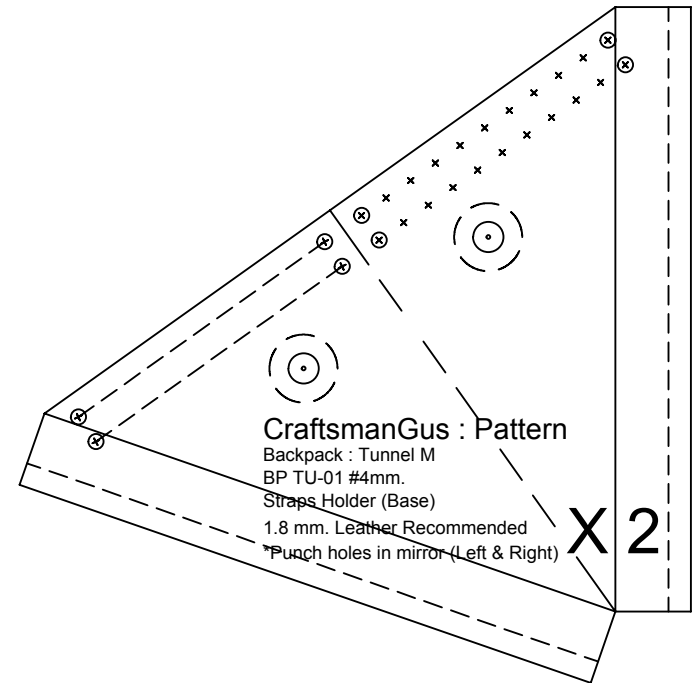
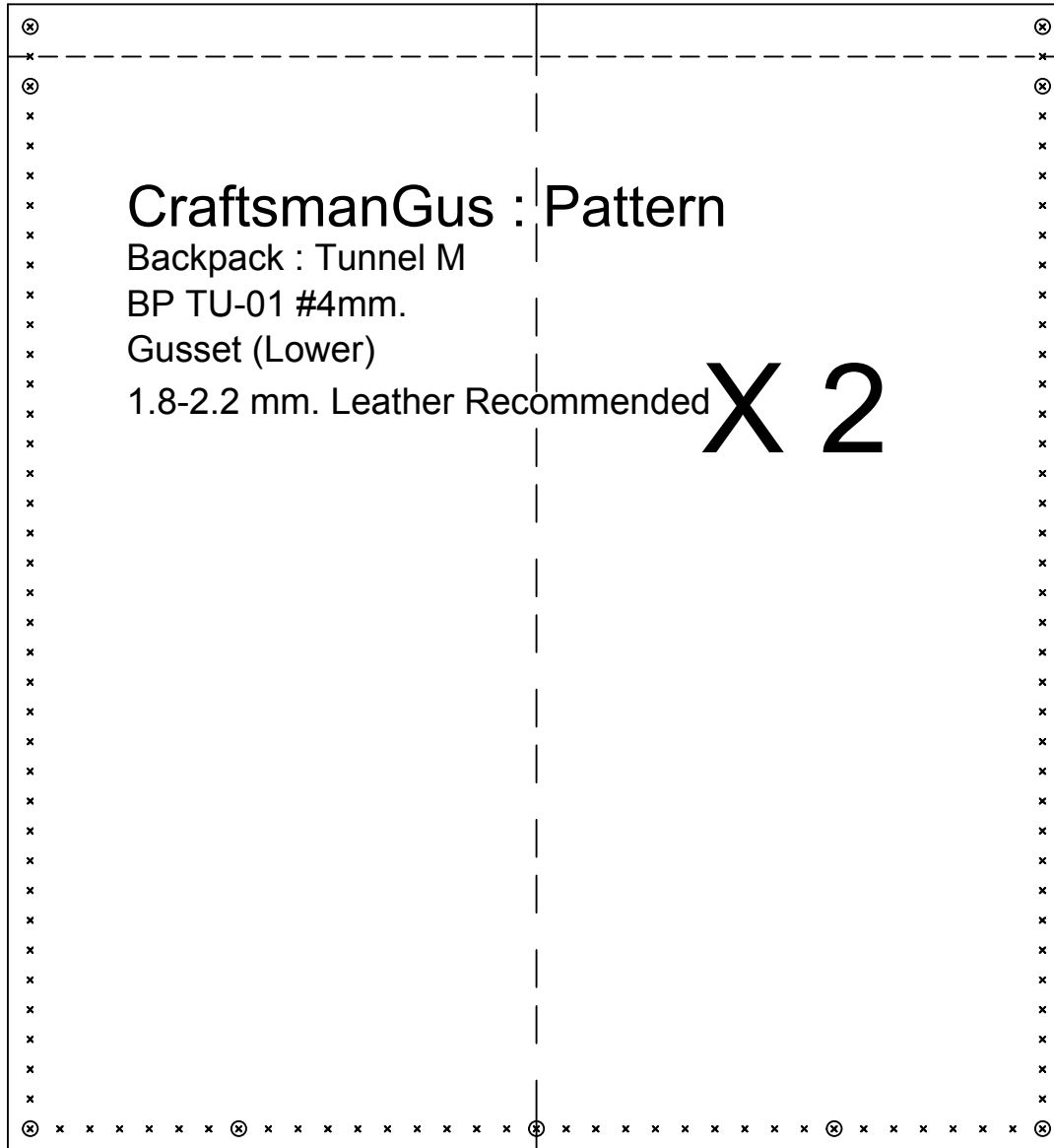

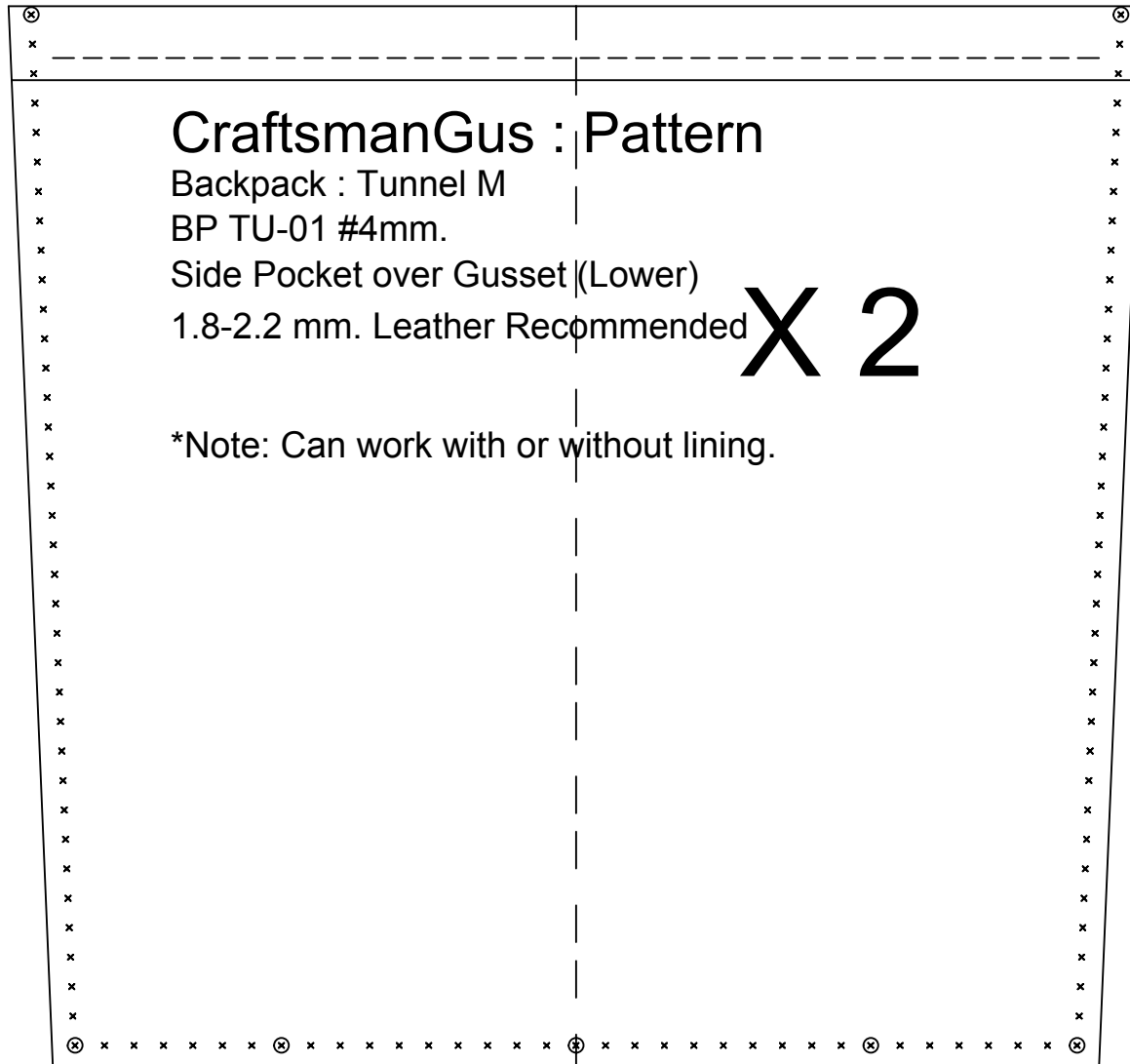



CraftsmanGus : Pattern Backpack : Tur

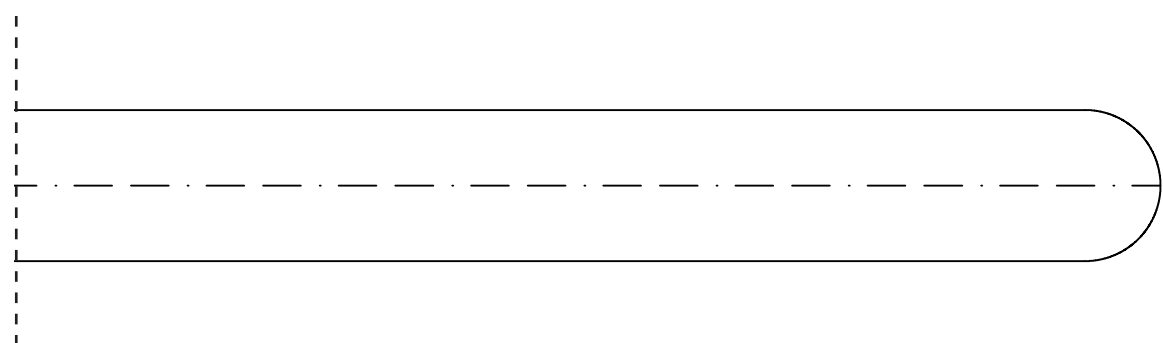
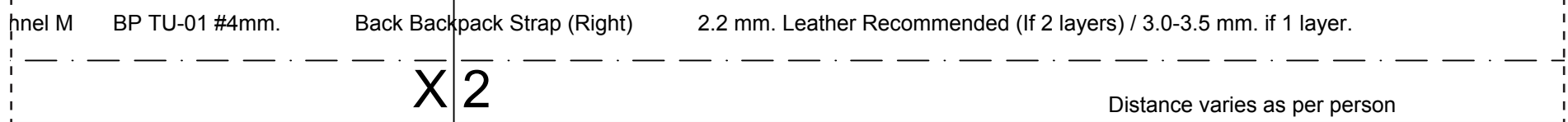
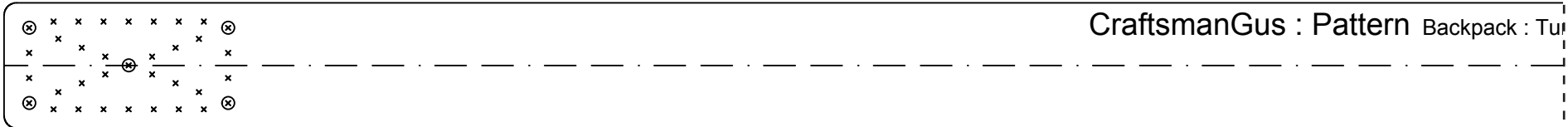

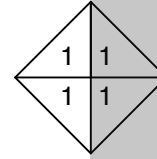

CraftsmanGus : Pattern

Backpack : Tunnel M

BP TU-01 #4mm.

Main Body

X 1

TILE TO PAGE 6

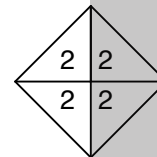

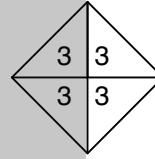

TILE TO PAGE 6

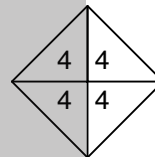

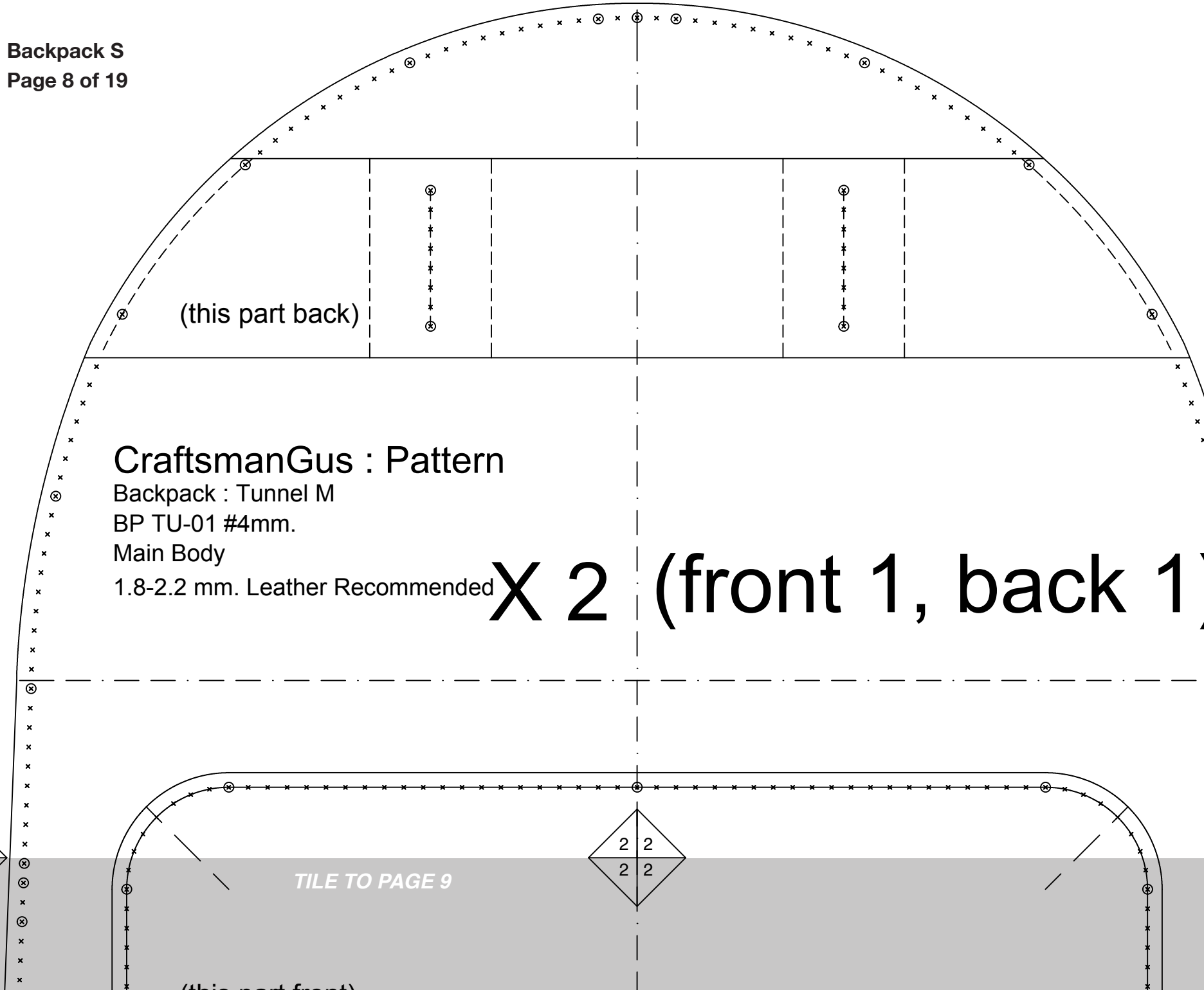

CraftsmanGus : Pattern

Backpack : Tunnel M

BP TU-01 #4mm.

Main Body

1.8-2.2 mm. Leather Recommended

X 2 (front 1, back 1)

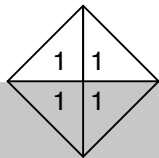

TILE TO PAGE 9

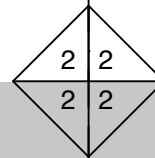

(this part front)

TILE TO PAGE 8

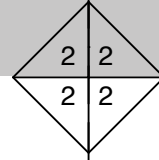
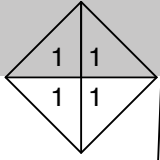

(this part front)

Backpack S
Page 9 of 19



(this part back)

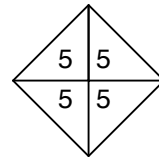
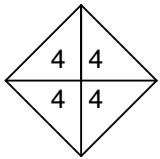

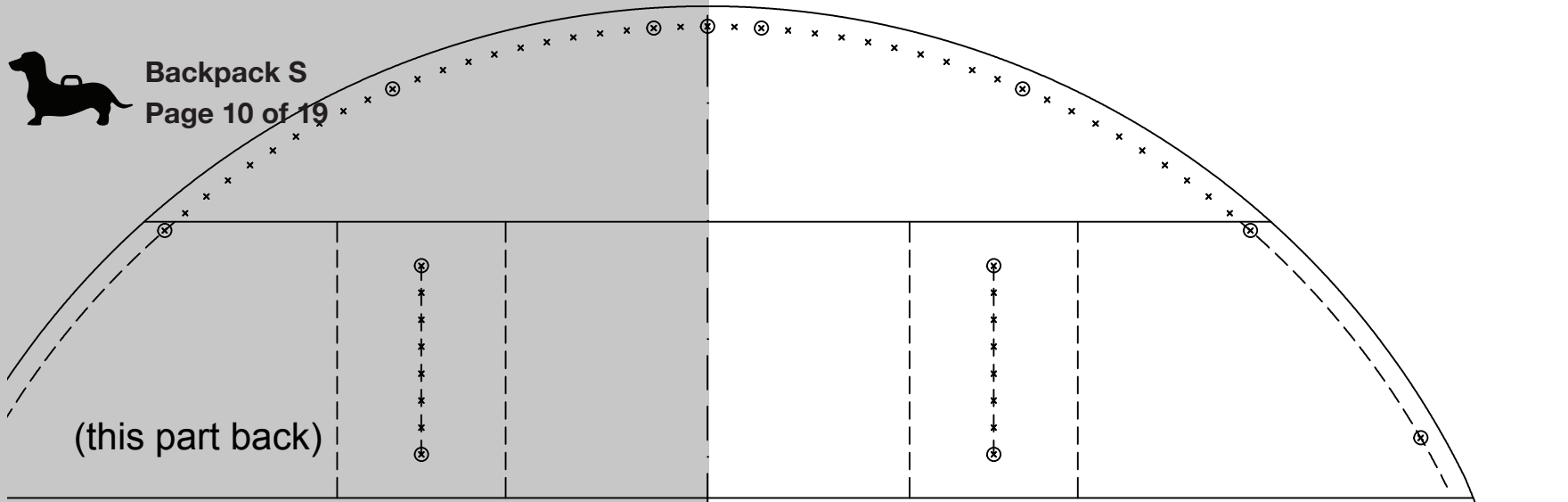

TILE TO PAGE 8

CraftsmanGus : Pattern

Backpack : Tunnel M

P TU-01 #4mm.

Main Body

8-2.2 mm. Leather Recommended

X 2 (front 1, back 1)

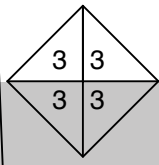
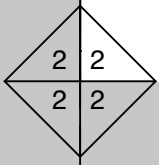
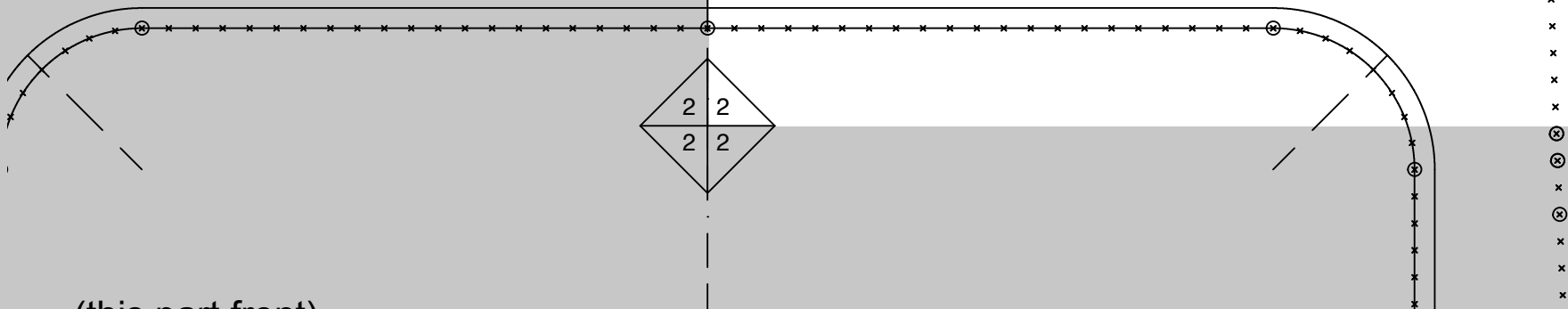

(this part front)

(this part back)



Backpack S
Page 11 of 19

(this part front)

TILE TO PAGE 9

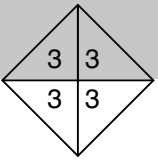
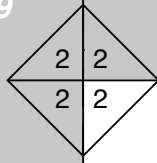

(this part back)

TILE TO PAGE 10

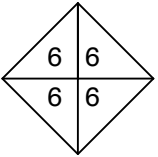
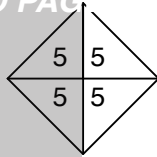



TILE TO PAGE 13

CraftsmanGus : Pattern

Backpack : Tunnel M

BP TU-01 #4mm.

Bottom

1.8-2.2 mm. Leather Recommended

X 1

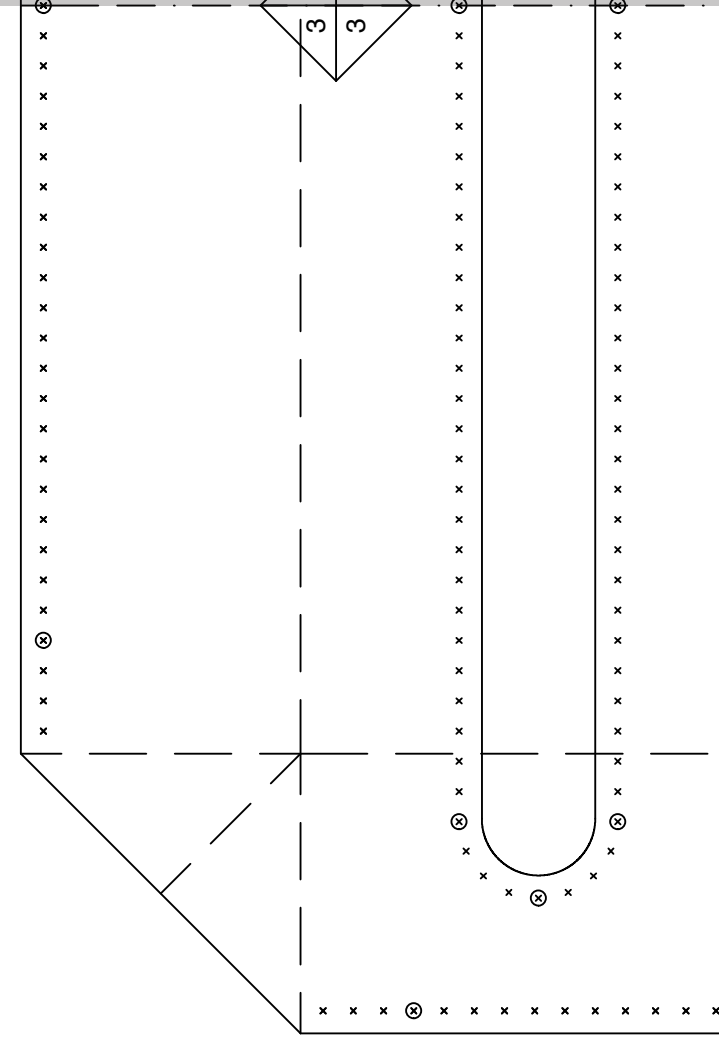
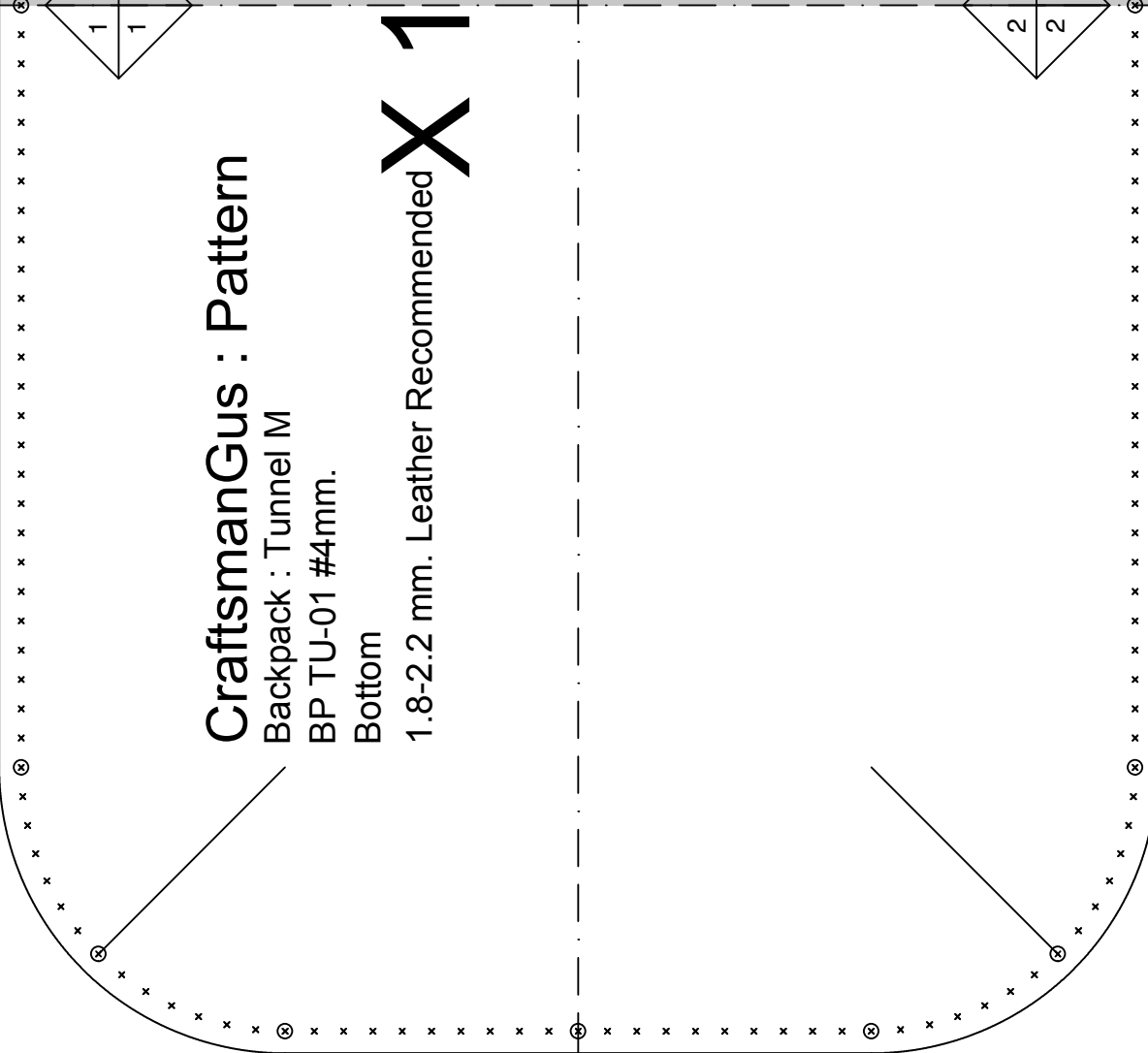
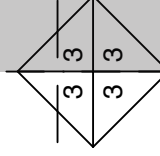
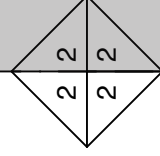
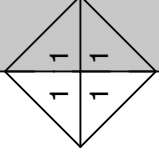

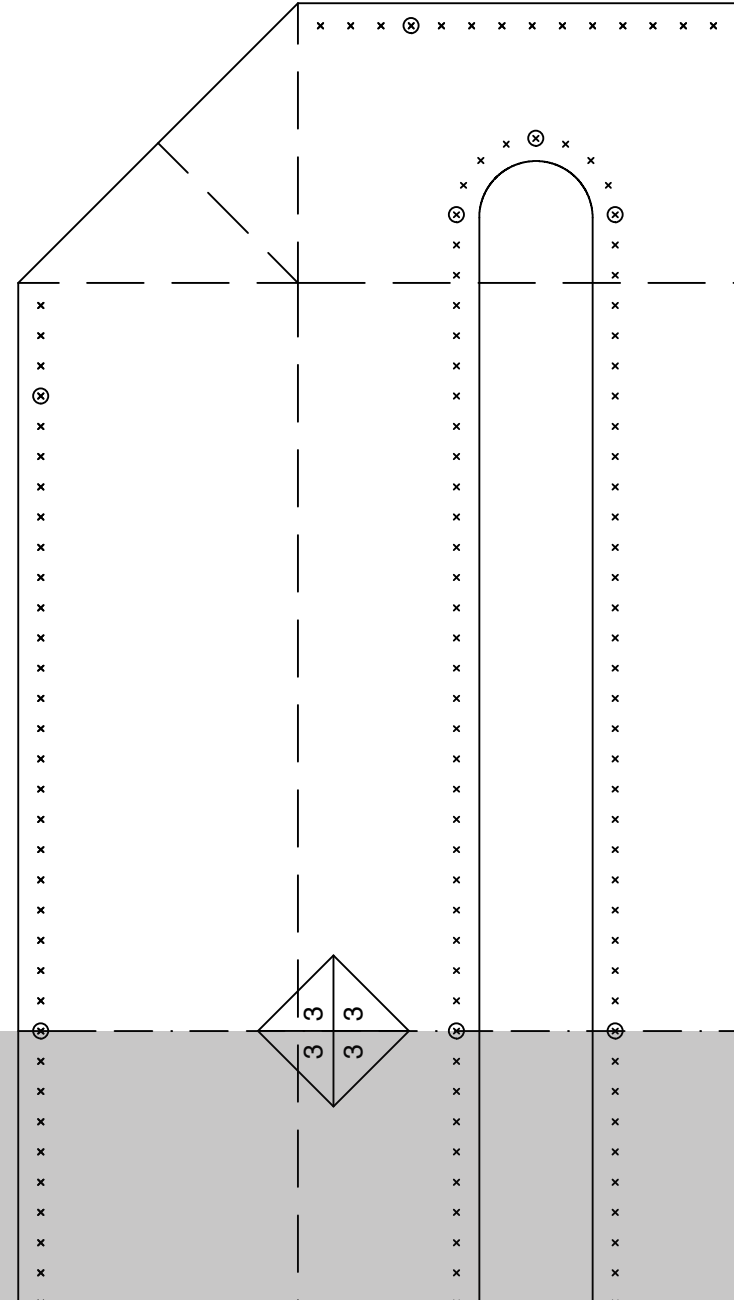
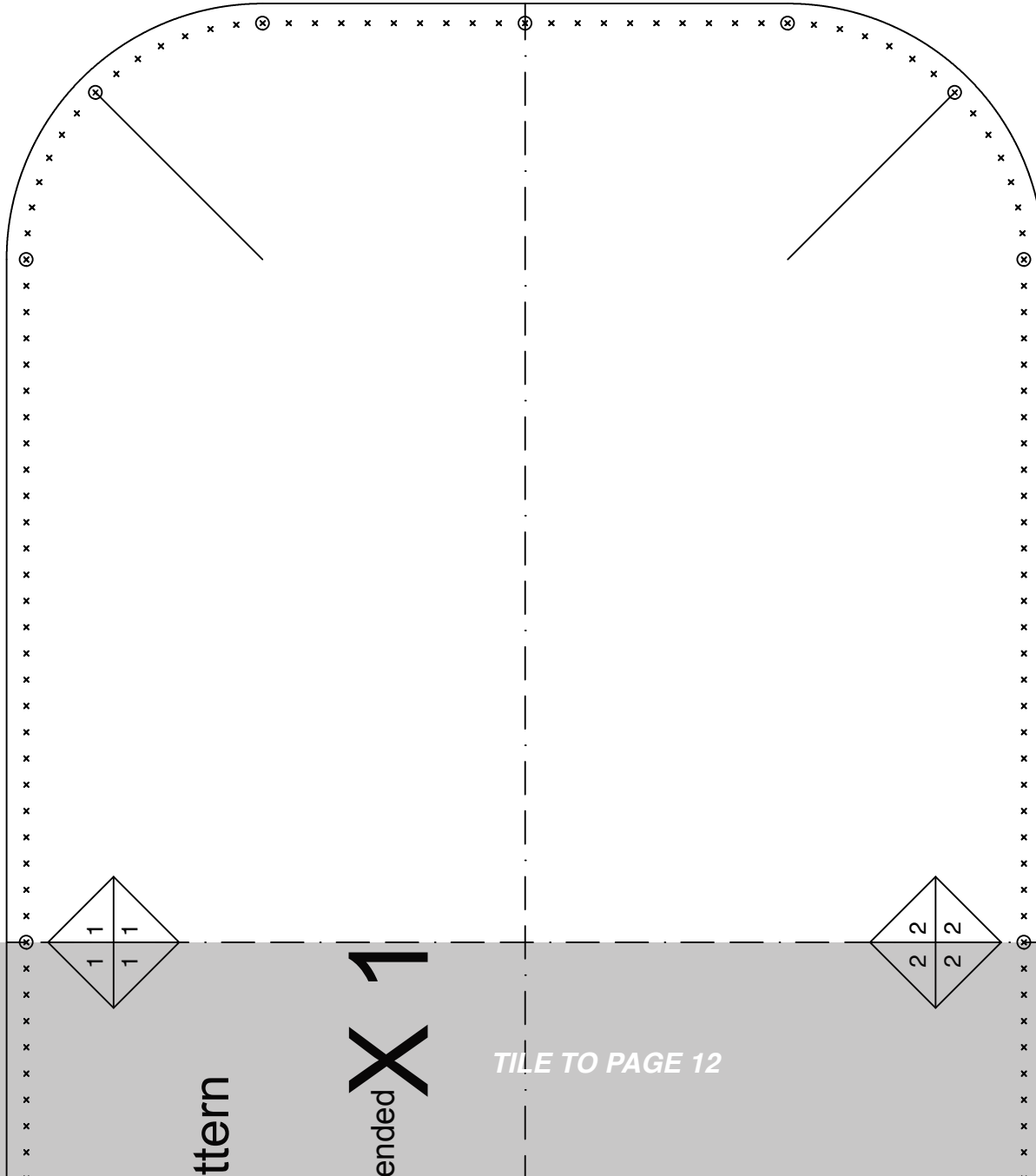

Pattern

ended X 1

TILE TO PAGE 12

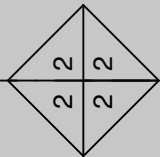

TILE TO PAGE 12

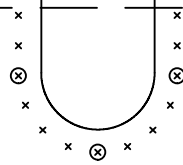
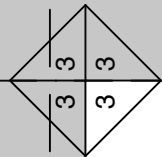

CraftsmanGus : Pattern

Backpack : Tunnel M

BP TU-01 #4mm.

Front Pocket

1.8-2.2 mm. Leather Recommended

X 1

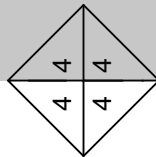



TILE TO PAGE 13

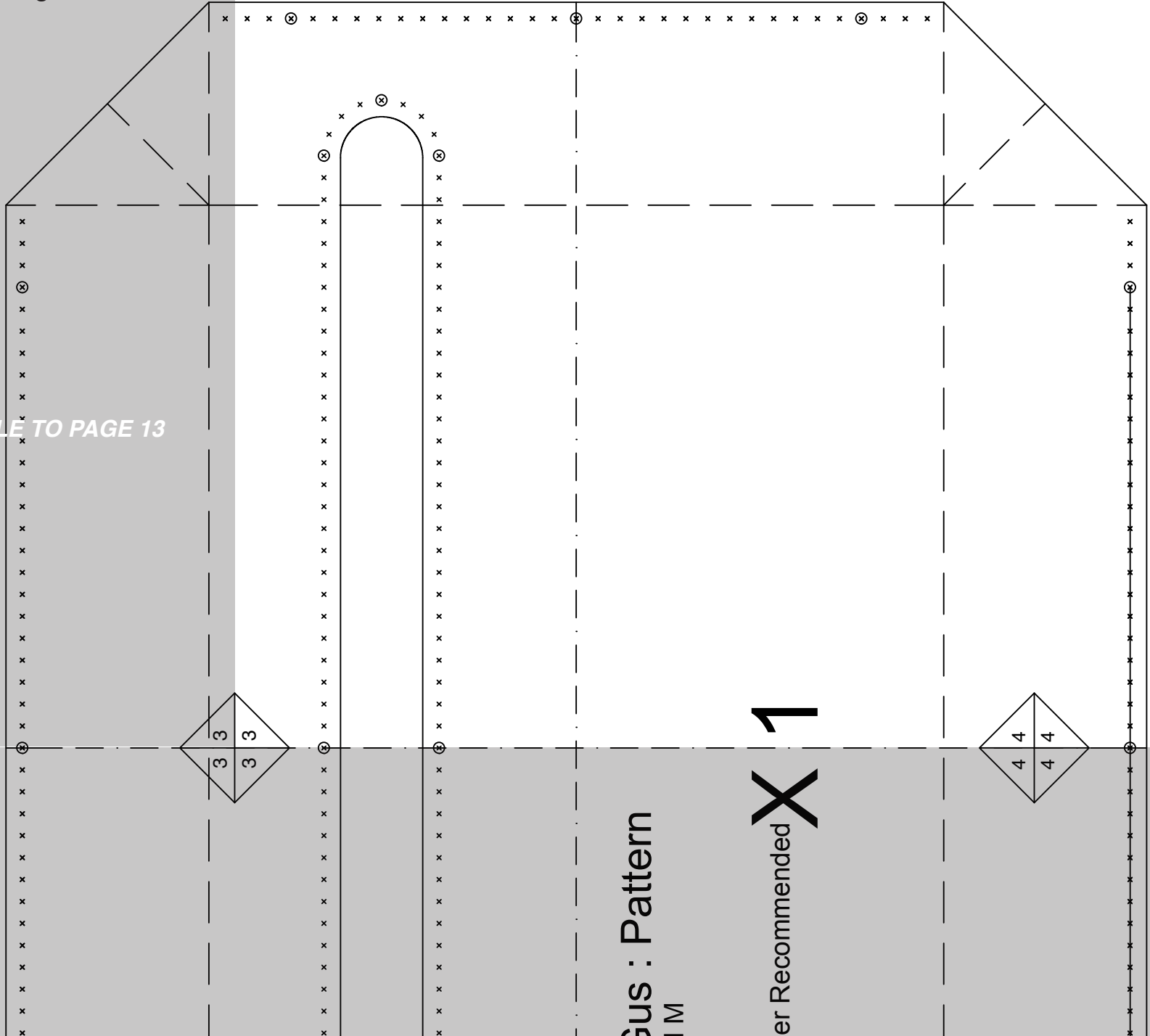

Bus : Pattern
M

er Recommended **X 1**

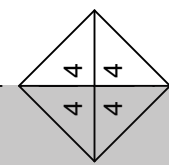



TILE TO PAGE 17

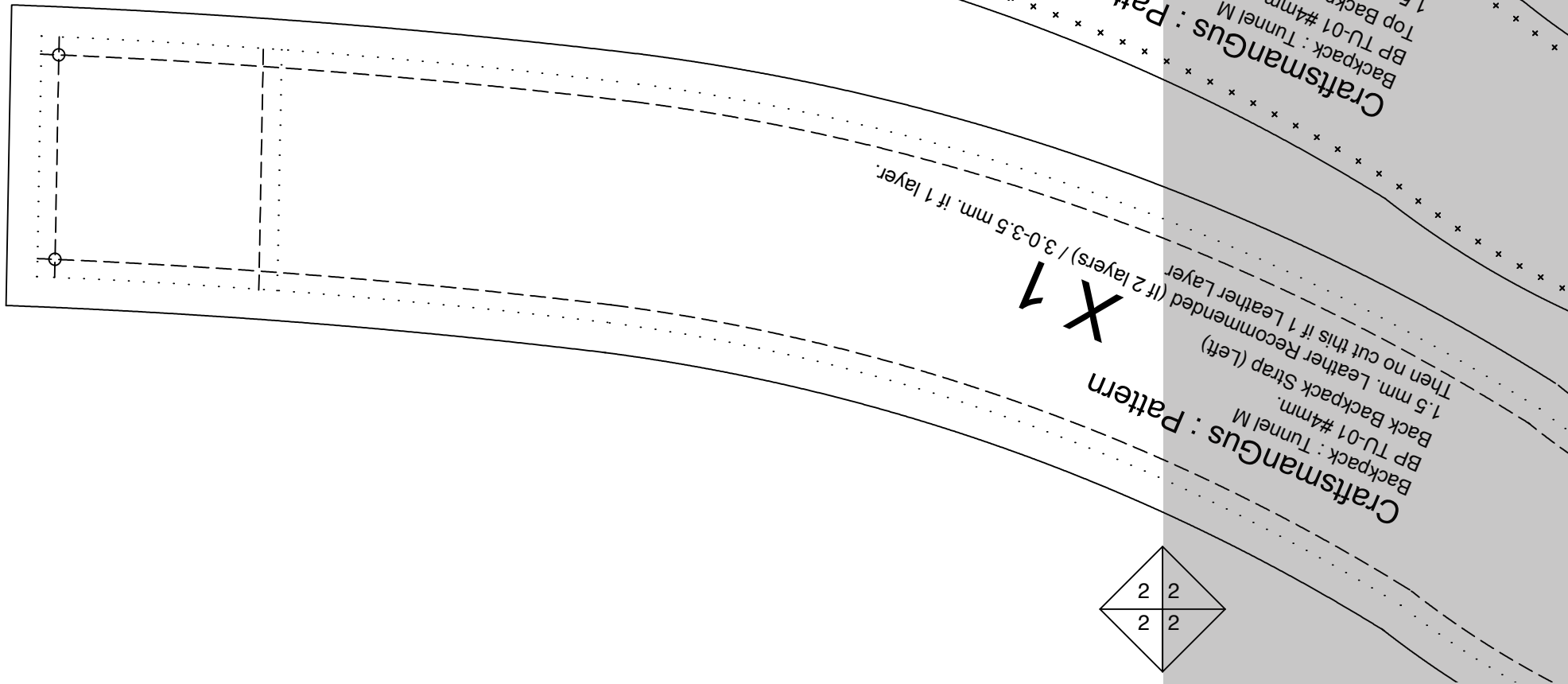
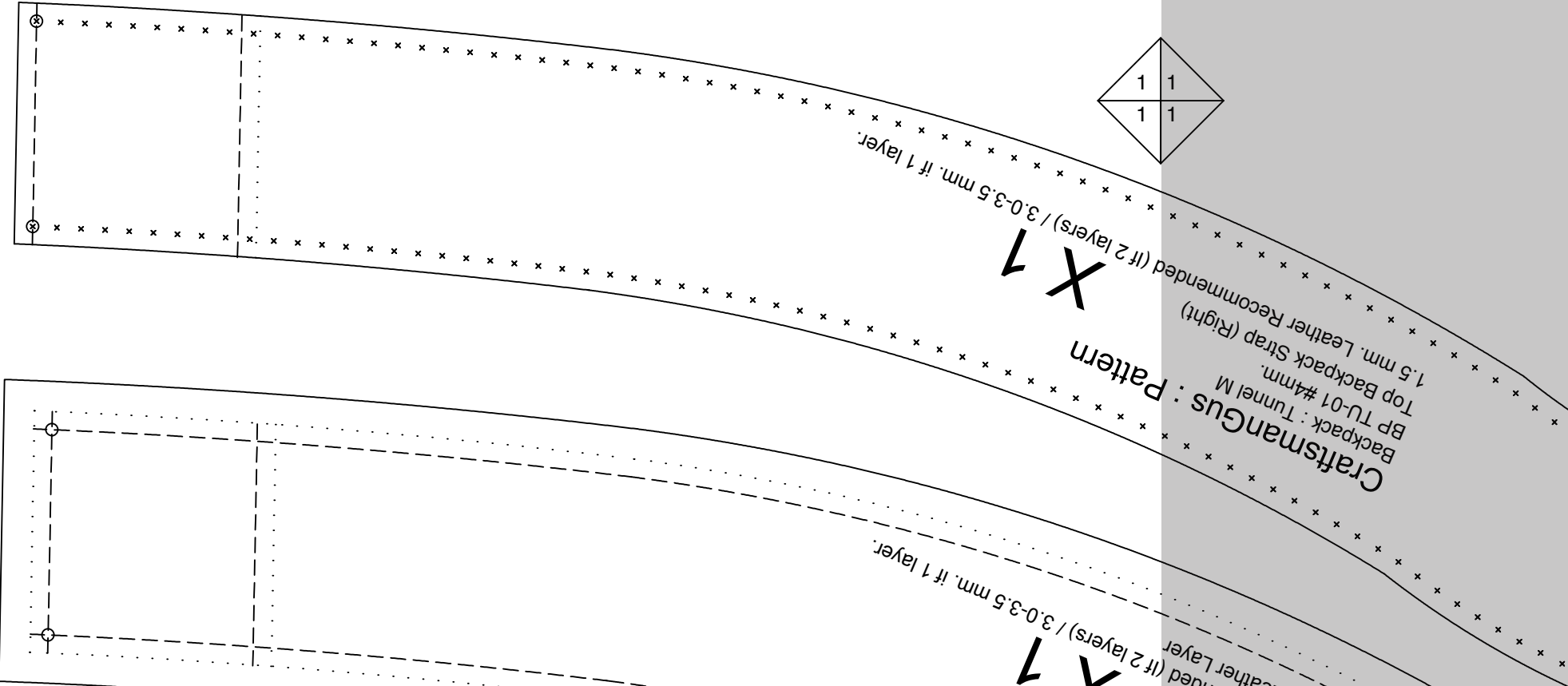

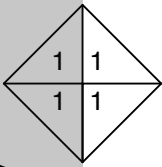

X 1

Craftsmangus : Pattern
Backpack : Tunnel M
BP TU-01 #4mm.
Top Backpack Strap (Right)
1.5 mm. Leather Recommended (if 2 layers) / 3.0-3.5 mm. if 1 layer.

X 1

Craftsmangus : Pattern
Backpack : Tunnel M
BP TU-01 #4mm.
Back Backpack Strap (Left)
1.5 mm. Leather Recommended (if 2 layers) / 3.0-3.5 mm. if 1 layer.
Then no cut this if 1 Leather Layer

TILE TO PAGE 16

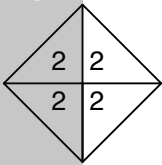

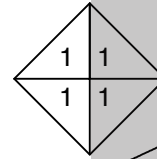

1.5 mm. Leather Recommended (if 2 layers) / 3.0-3.5 mm. if 1 layer.
Then no cut this if 1 Leather Layer
Back Backpack Strap (Right)
BP TU-01 #4mm.
Backpack : Tunnel M
CraftsmanGus : Pattern

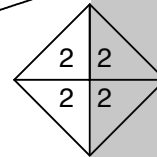
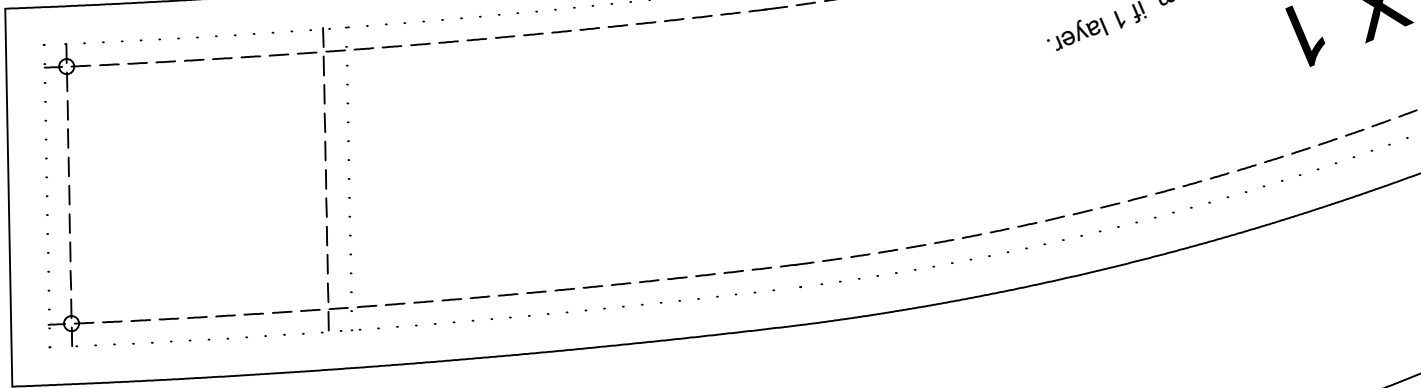

1.5 mm. Leather Recommended (if 2 layers) / 3.0-3.5 mm. if 1 layer.
Top Backpack Strap (Left)
BP TU-01 #4mm.
Backpack : Tunnel M
CraftsmanGus : Pattern

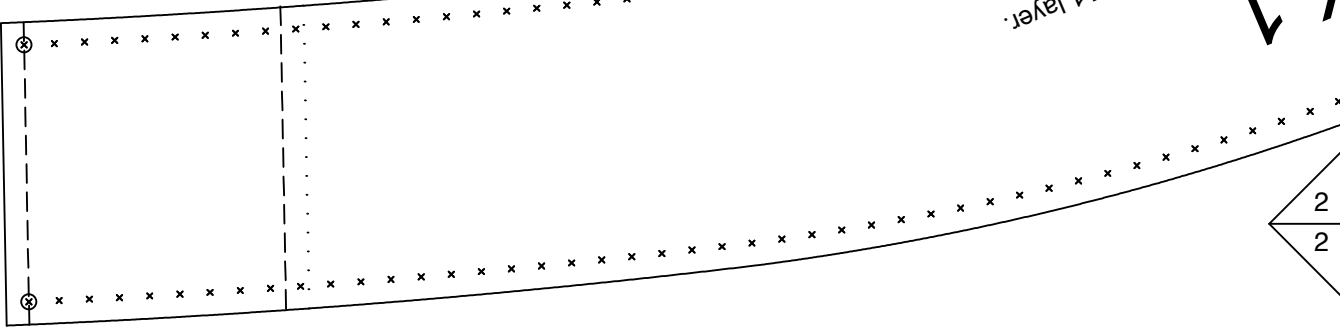

TILE TO PAGE 19



TILE TO PAGE 18

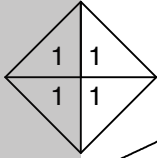

1.5 mm. Leather Recommended (if 2 layers) / 3.0-3.5 mm. if 1 layer.
Back Backpack Strap (Right)
BP TU-01 #4mm.
Backpack : Tunnel M
CraftsmanGus : Pattern X 1

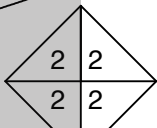
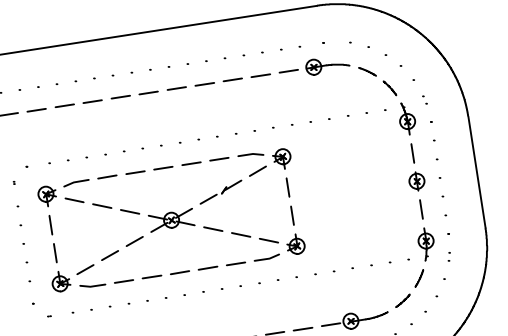

1.5 mm. Leather Recommended (if 2 layers) / 3.0-3.5 mm. if 1 layer.
Top Backpack Strap (Left)
BP TU-01 #4mm.
Backpack : Tunnel M
CraftsmanGus : Pattern X 1

