

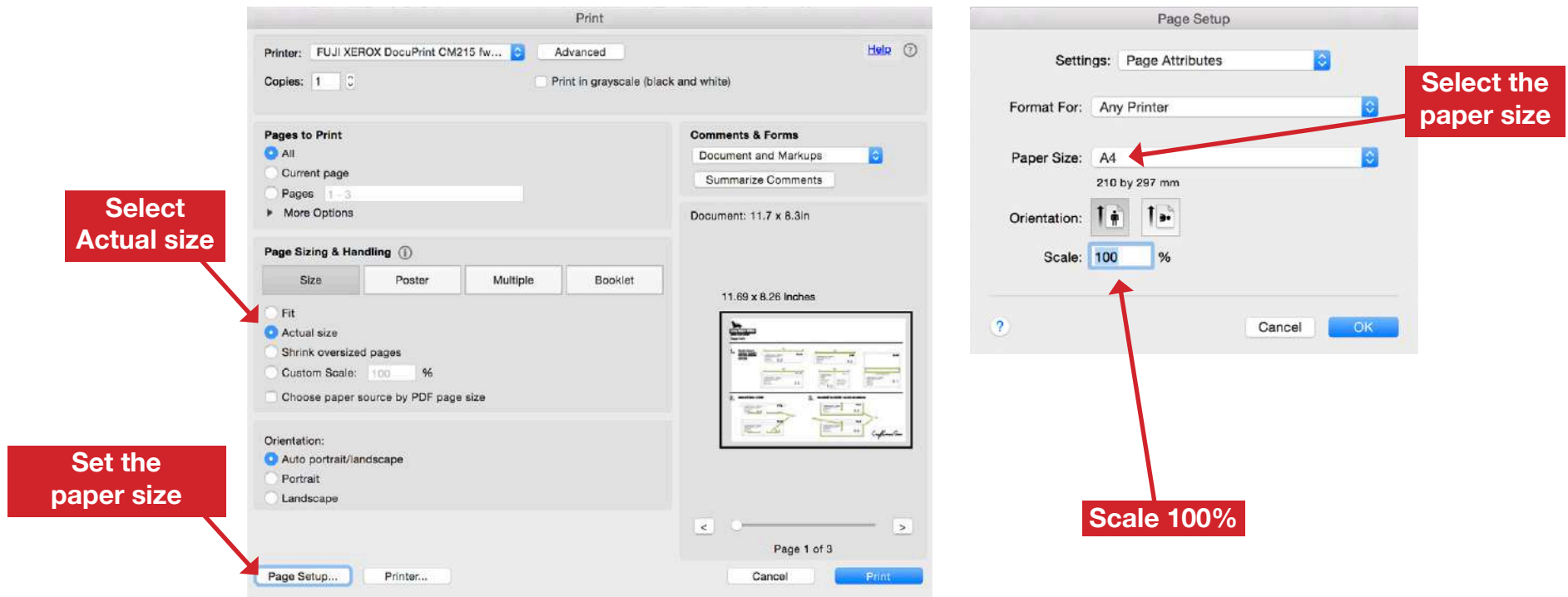

## PRINTING INSTRUCTION

1. File > Print
2. Click on “Page Setup” button make sure your paper size is set to the paper size that you will print and Scale at 100%
3. In “Pages Sizing & Handling” click on “Size” button and select “Actual size”



### IMPORTANT NOTE:

- **ADOBE ACROBAT READER (FREE SOFTWARE)** is recommended to open and print the patterns

link for free download

<https://get.adobe.com/reader>

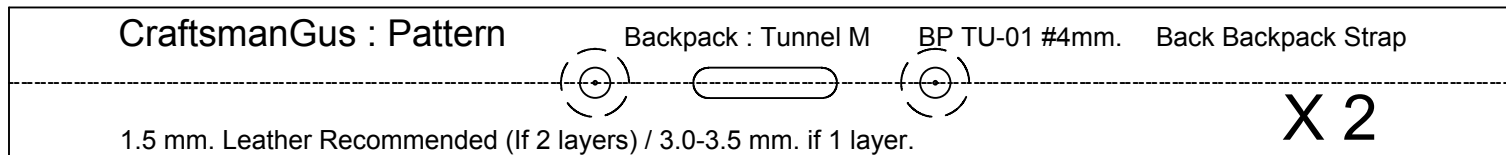
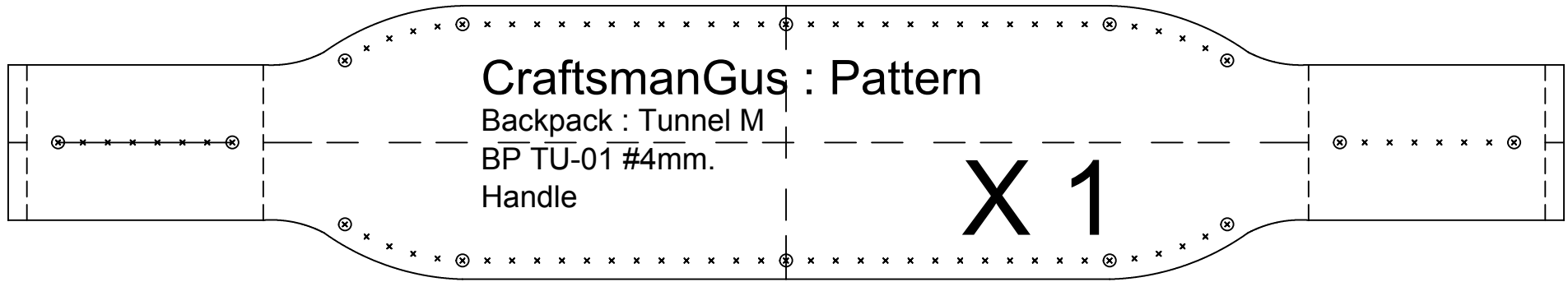

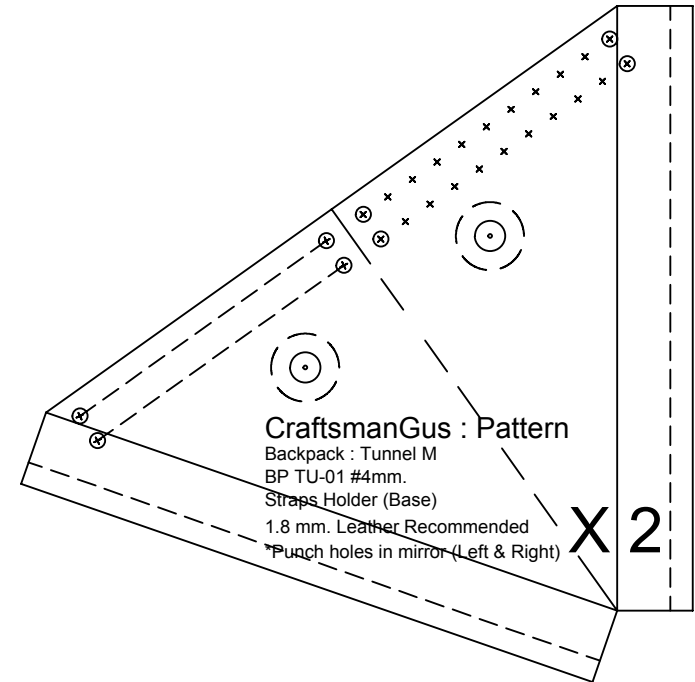
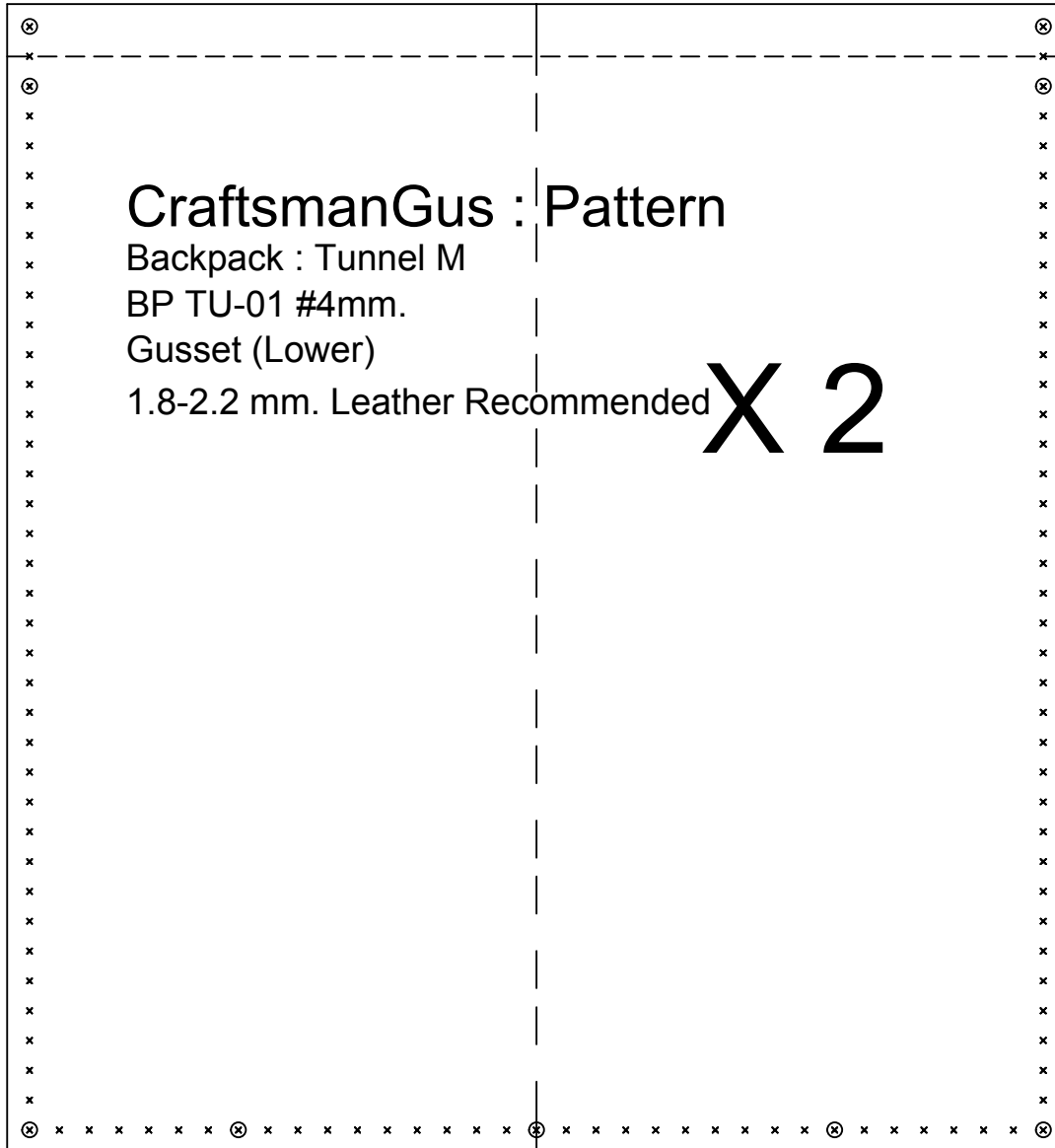

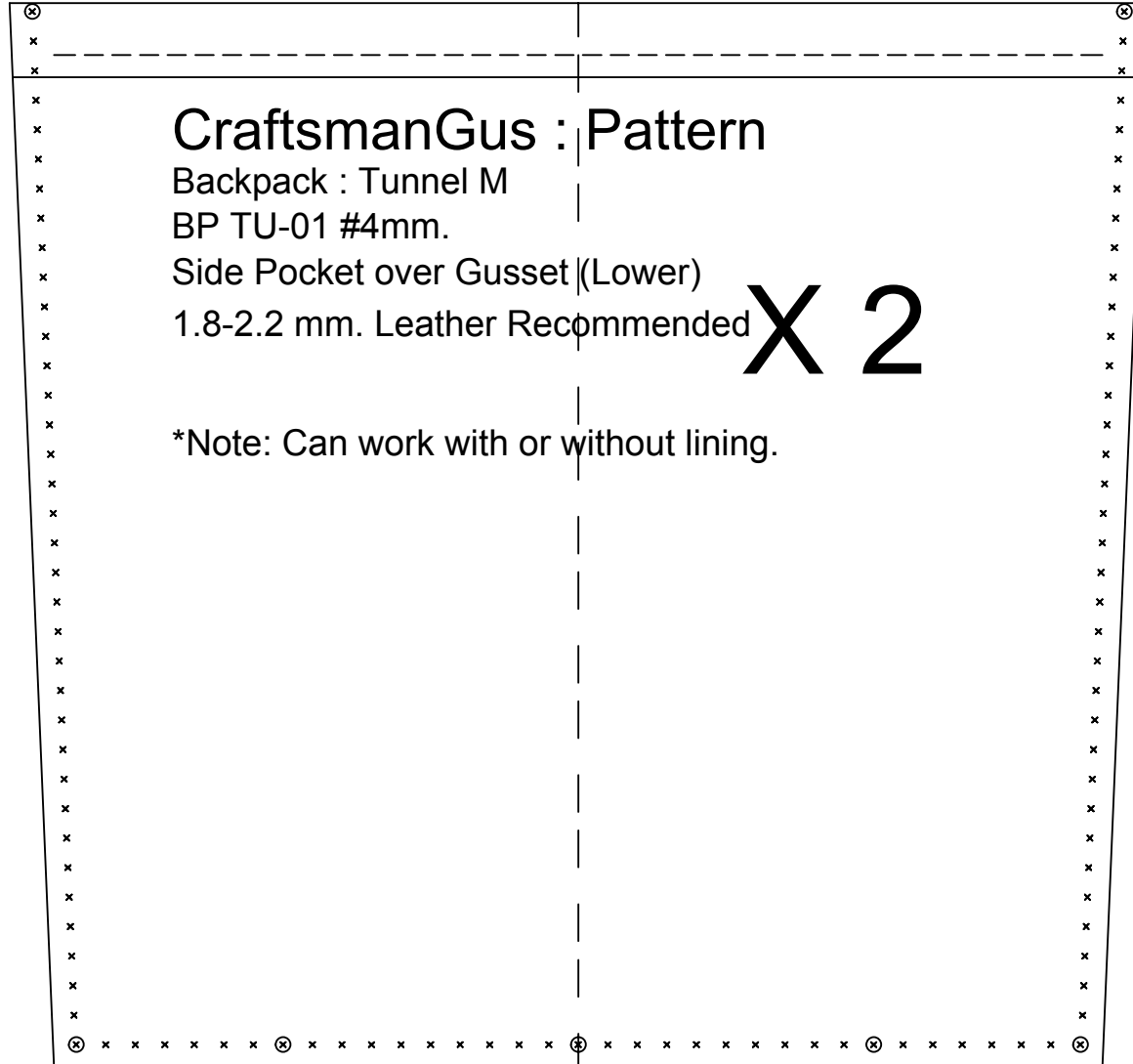

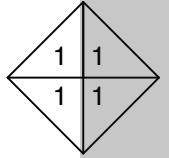

# CraftsmanGus : Pattern

Backpack : Tunnel M

BP TU-01 #4mm.

Main Body

# X 1

TILE TO PAGE 5

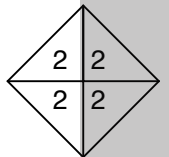
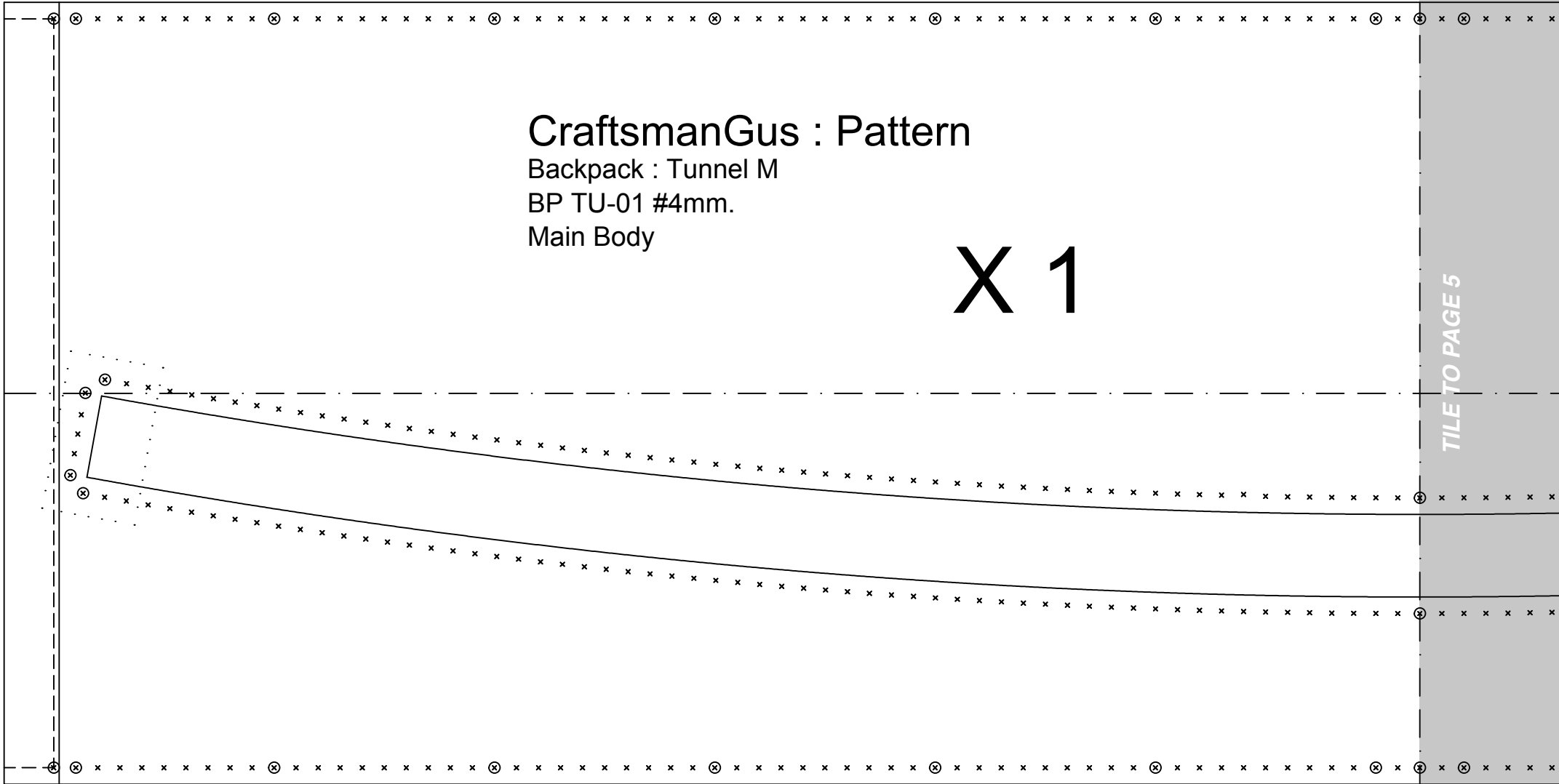

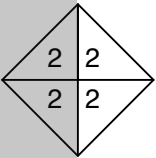
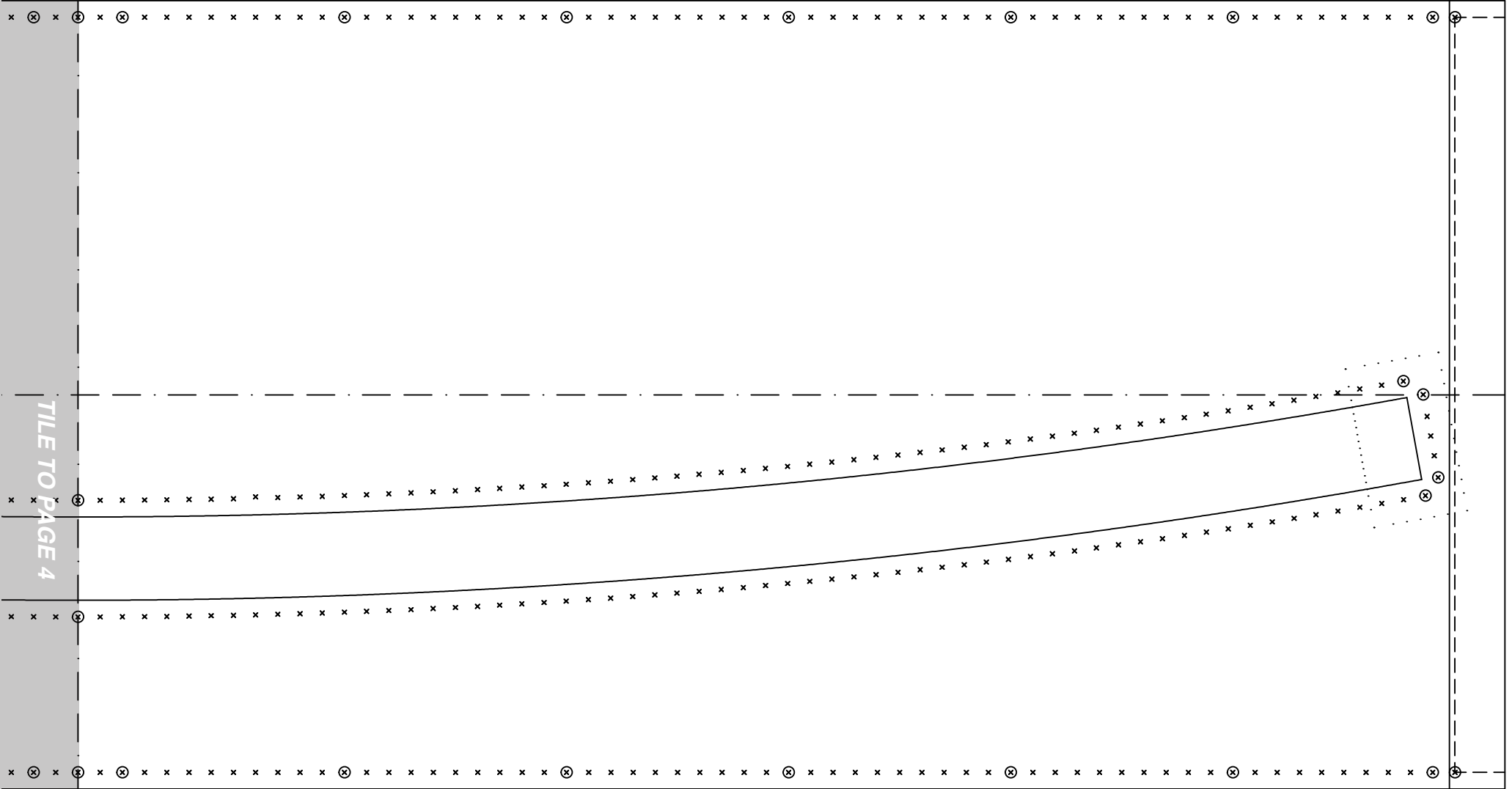
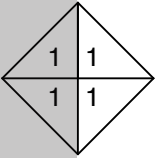

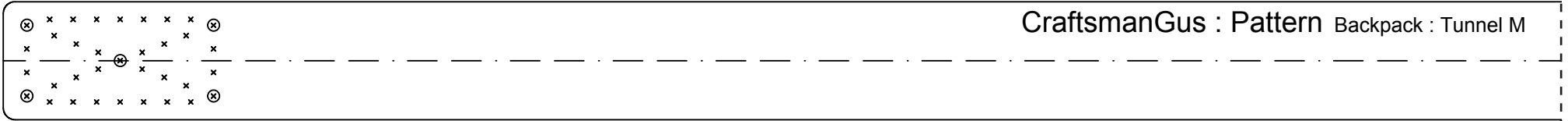

BP TU-01 #4mm. Back Backpack Strap (Right) 2.2 mm. Leather Recommended (If 2 layers) / 3.0-3.5 mm. if 1 layer.

X 2

Distance varies as per person

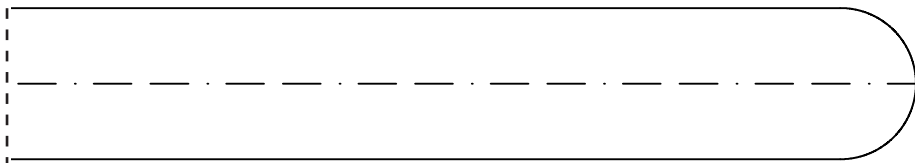

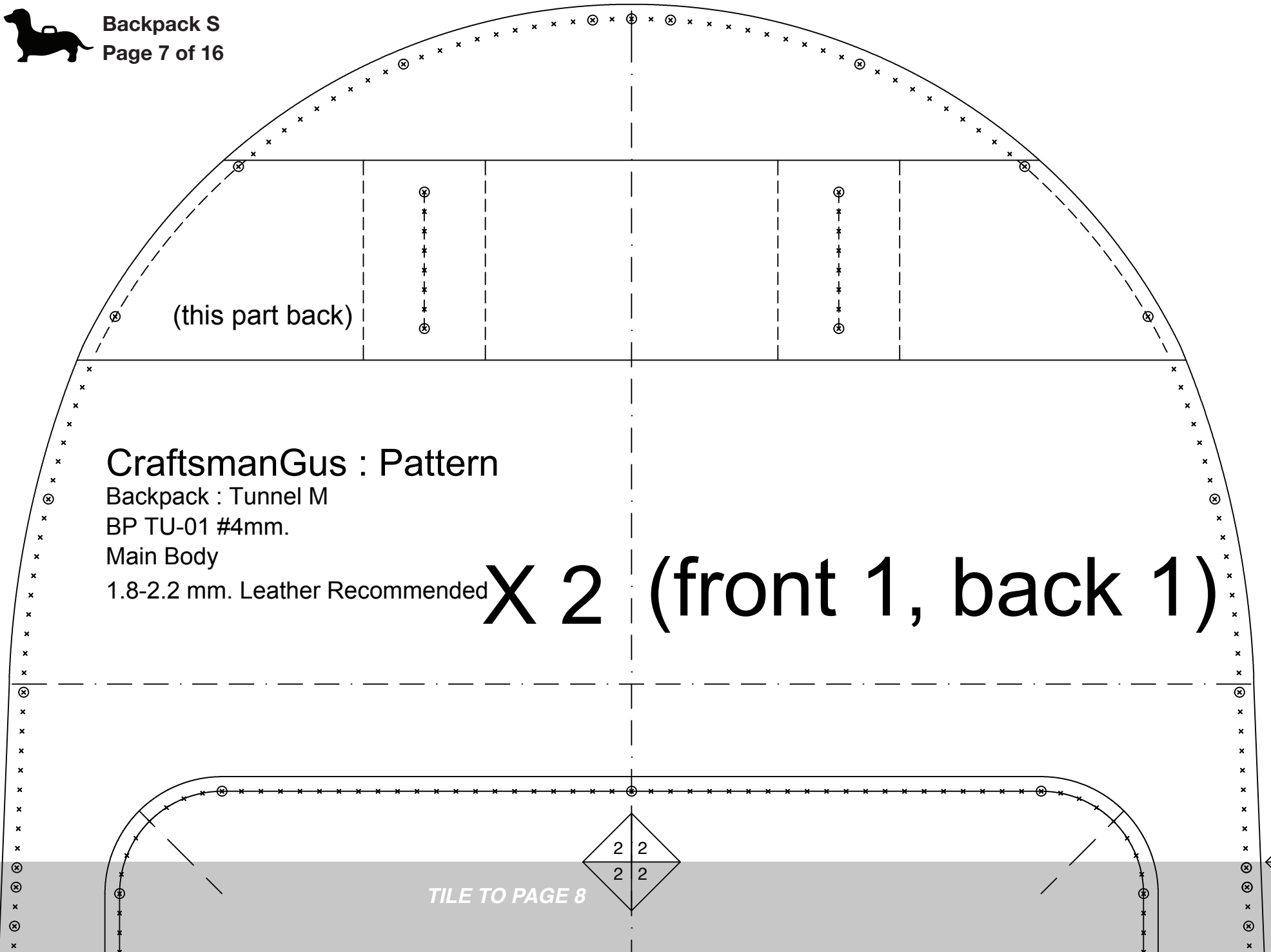

(this part back)

## CraftsmanGus : Pattern

Backpack : Tunnel M

BP TU-01 #4mm.

Main Body

1.8-2.2 mm. Leather Recommended

# X 2 (front 1, back 1)

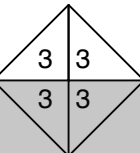
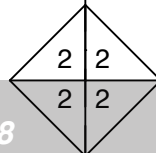
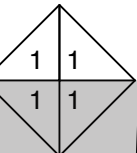

TILE TO PAGE 8





TILE TO PAGE 7

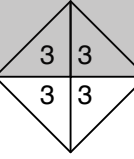
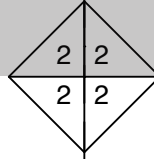
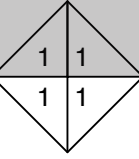

(this part front)

(this part back)

(this part back)

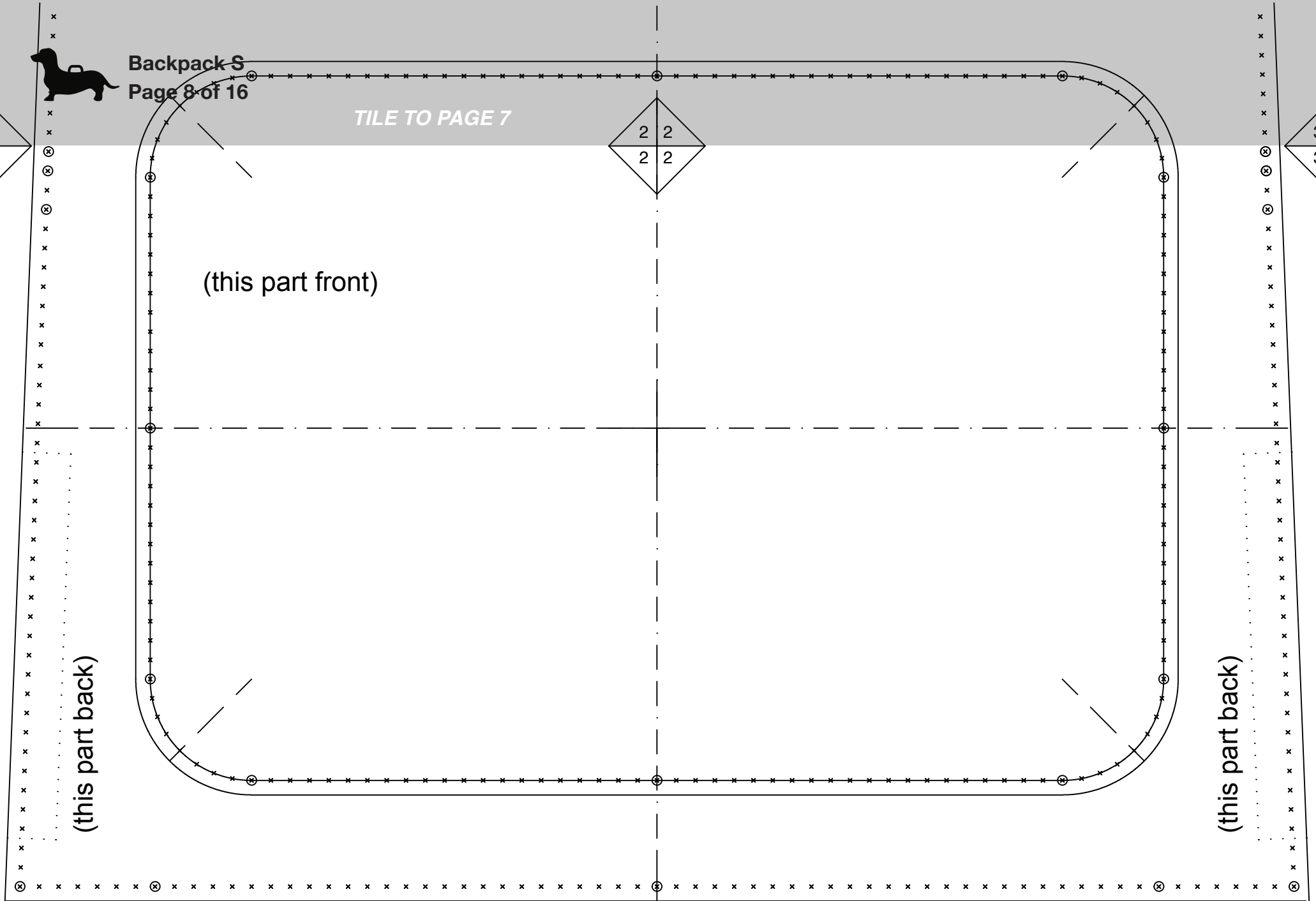



TILE TO PAGE 10

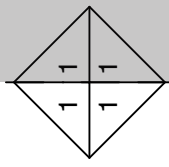

# CraftsmanGus : Pattern

Backpack : Tunnel M  
BP TU-01 #4mm.

Bottom

1.8-2.2 mm. Leather Recommended **X 1**

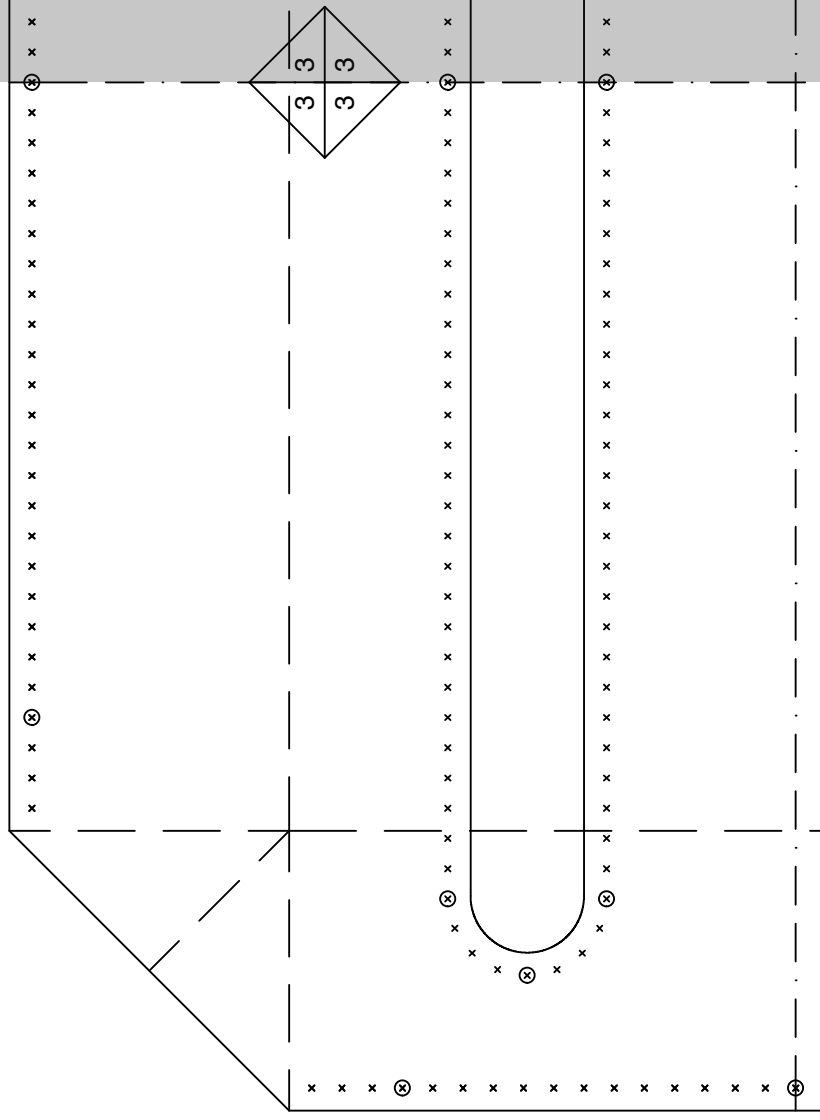
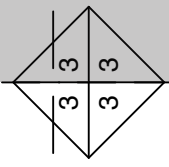
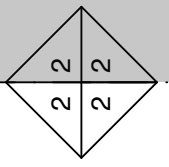

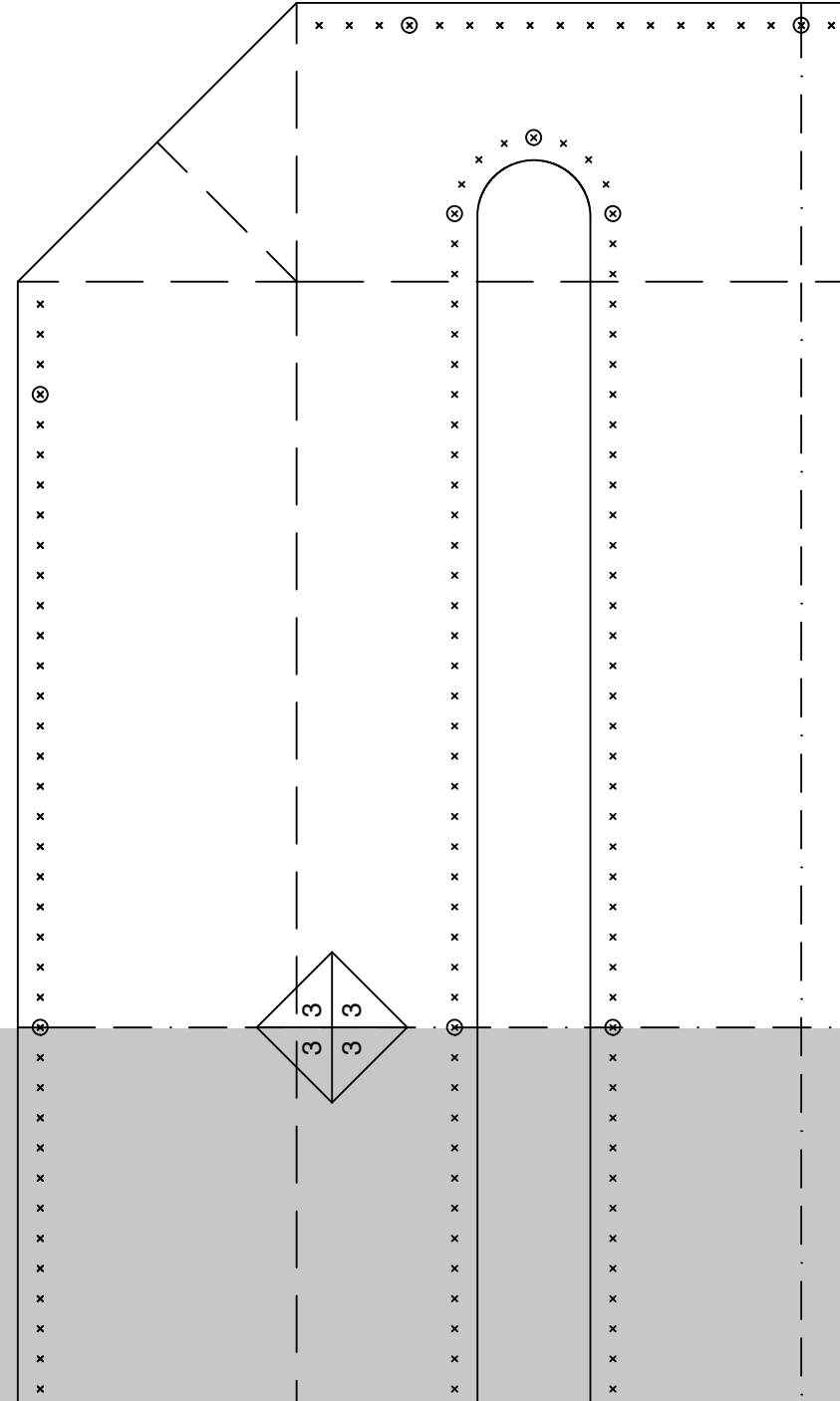
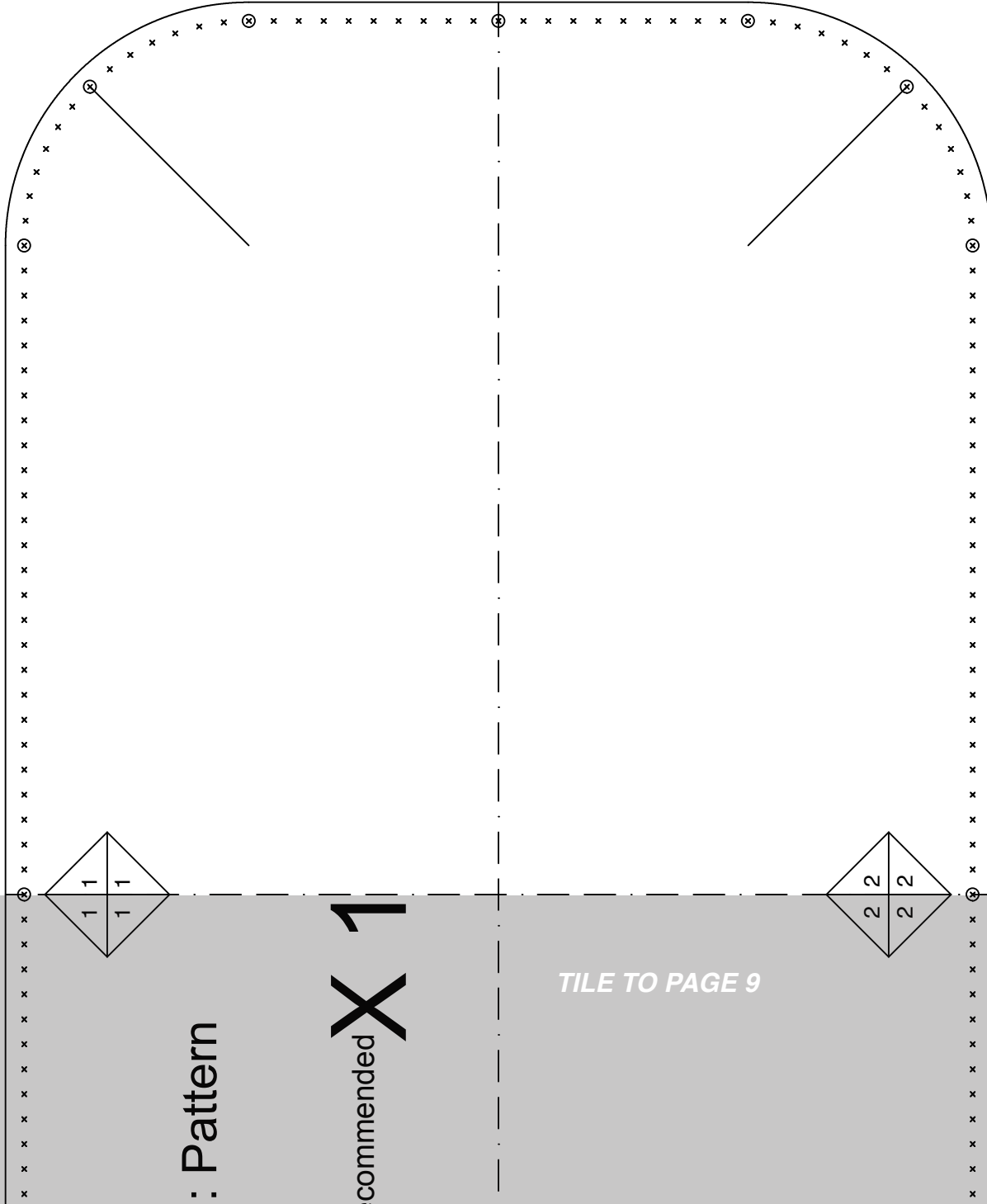

: Pattern

commended **X 1**

TILE TO PAGE 9

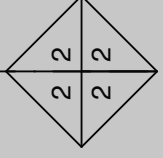

TILE TO PAGE 9

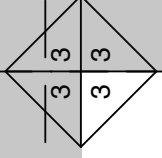

# CraftsmanGus : Pattern

Backpack : Tunnel M

BP TU-01 #4mm.

Front Pocket

1.8-2.2 mm. Leather Recommended **X 1**

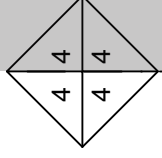

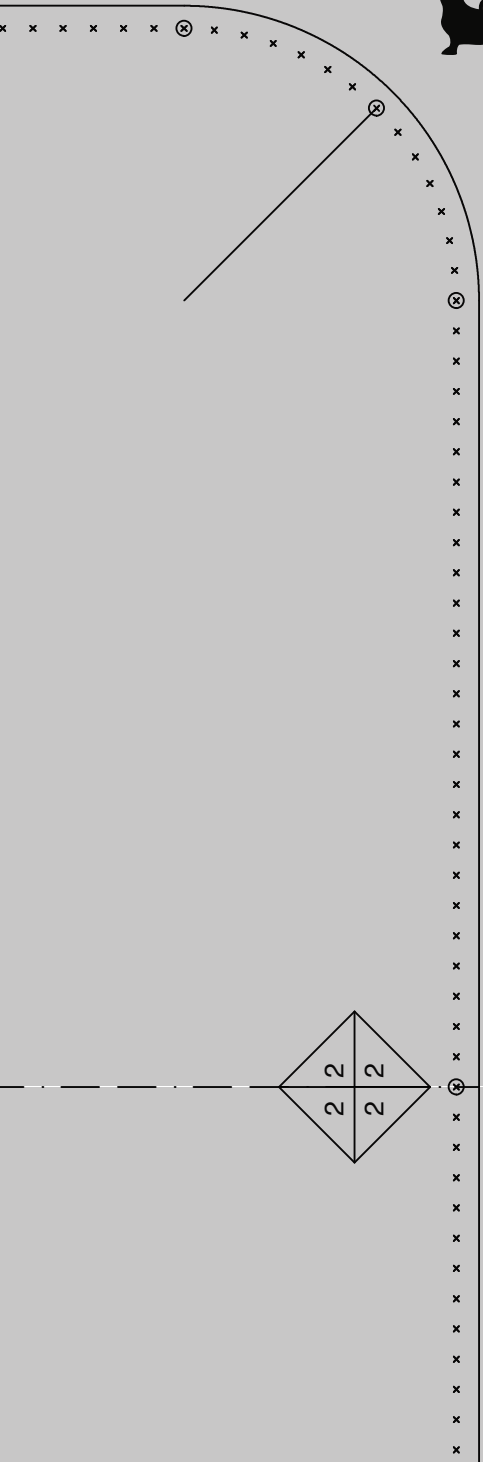

TILE TO PAGE 10

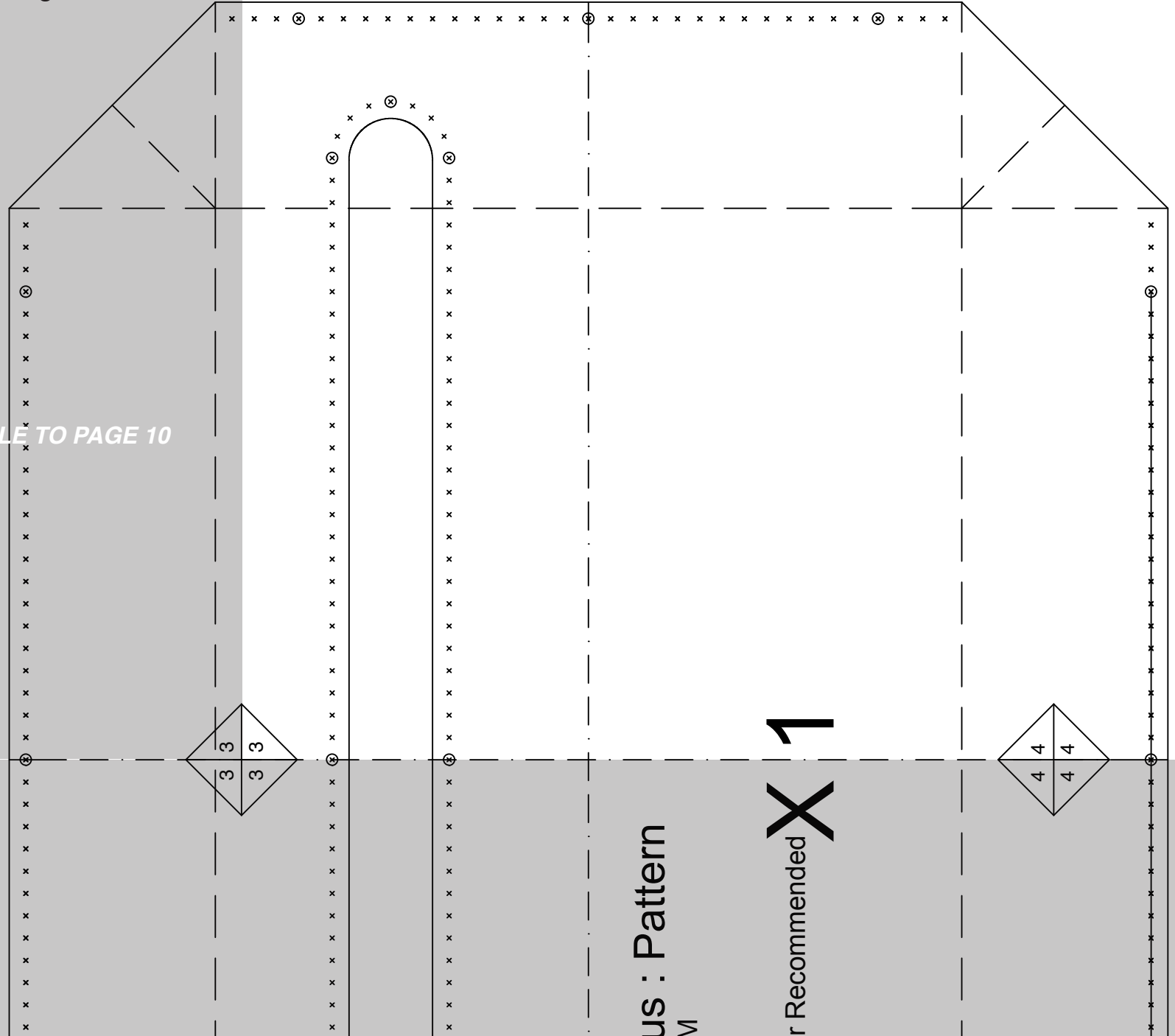

us : Pattern  
M

r Recommended **X 1**

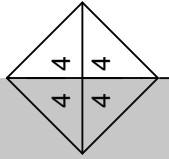

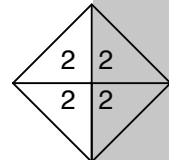
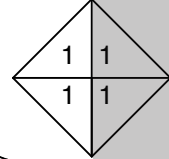
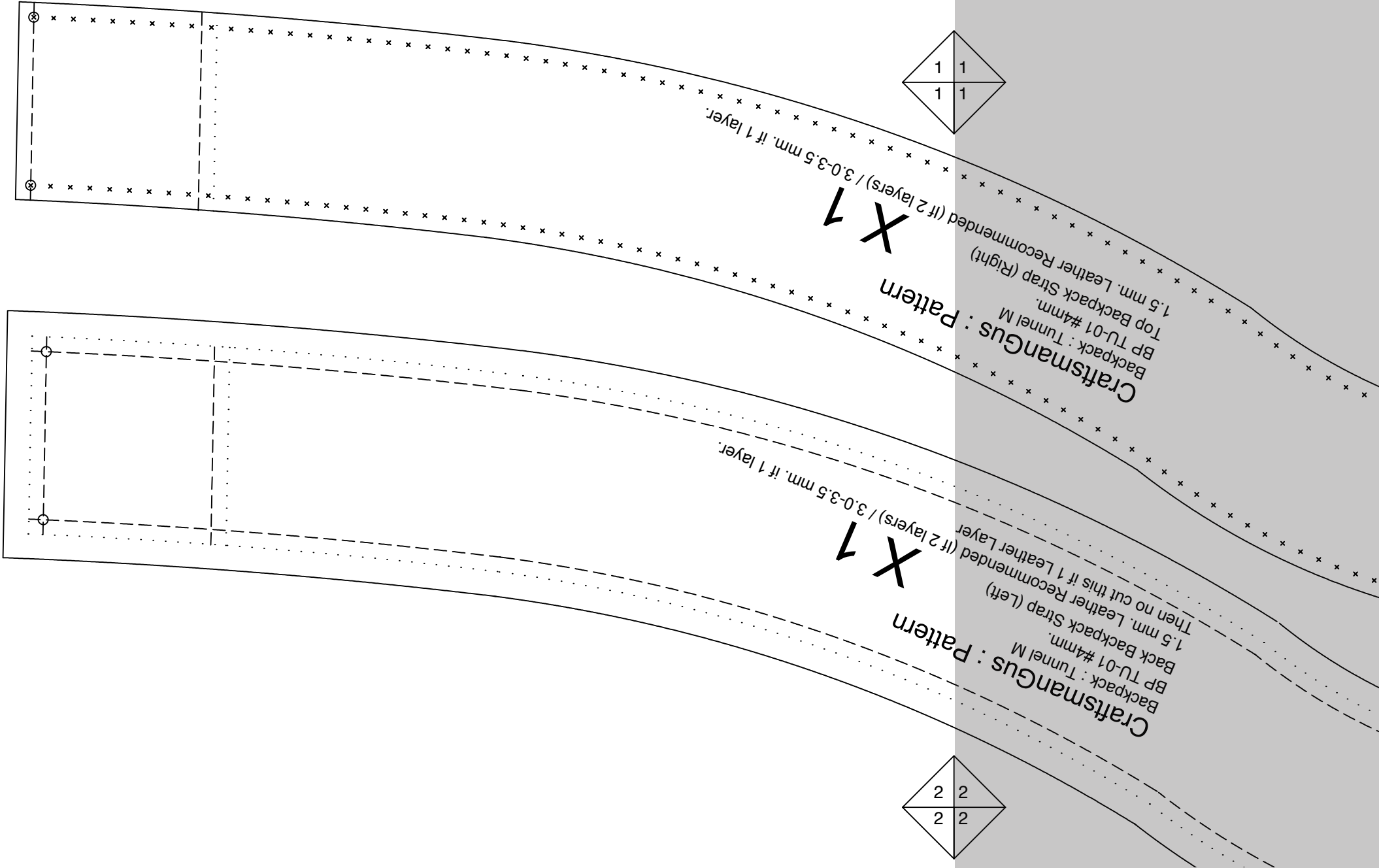

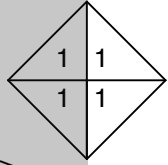

**Craftsmangus : Pattern**  
 Backpack : Tunnel M  
 BP TU-01 #4mm.  
 Top Backpack Strap (Right)  
 1.5 mm. Leather Recommended (if 2 layers) / 3.0-3.5 mm. if 1 layer.

X 1

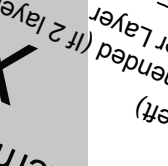

**Craftsmangus : Pattern**  
 Backpack : Tunnel M  
 BP TU-01 #4mm.  
 Back Backpack Strap (Left)  
 1.5 mm. Leather Recommended (if 2 layers) / 3.0-3.5 mm. if 1 layer.  
 Then no cut this if 1 Leather Layer

X 1

TILE TO PAGE 13



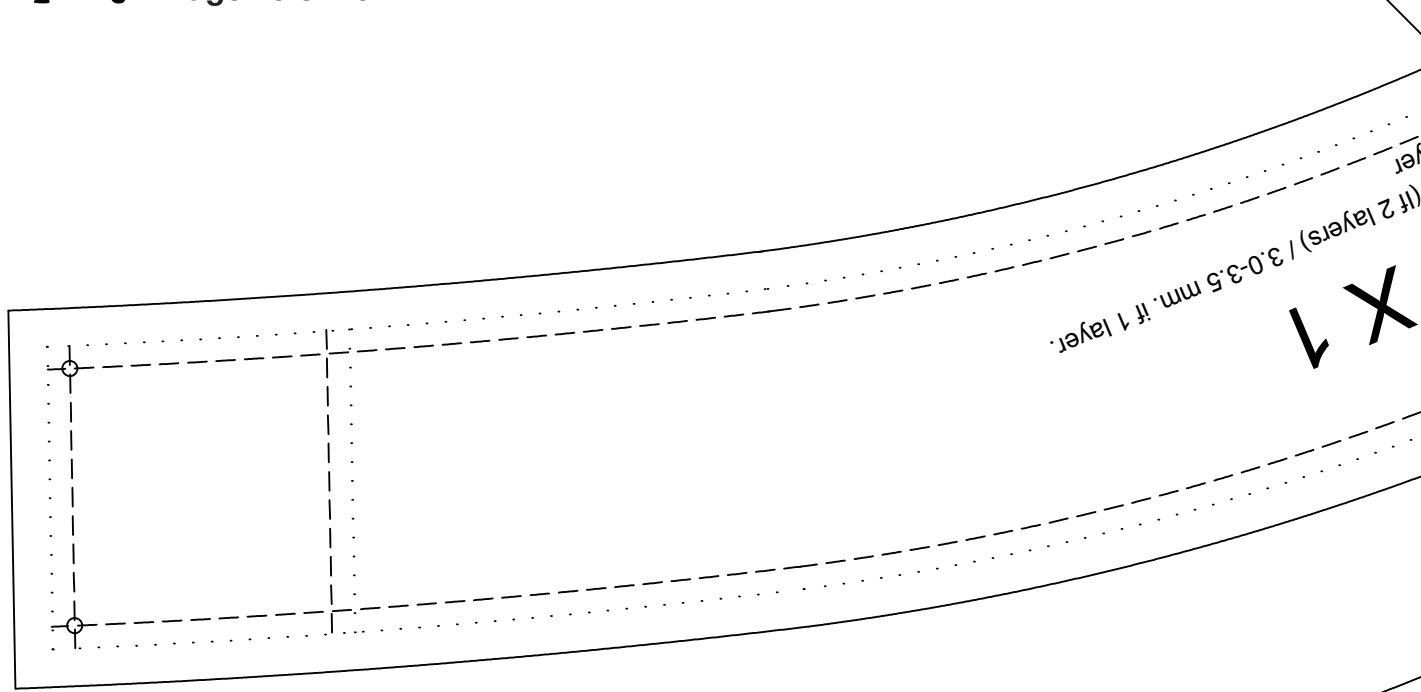
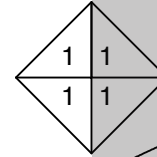

Then no cut this if 1 Leather Layer  
1.5 mm. Leather Recommended  
Back Backpack Strap (Right)  
BP TU-01 #4mm.  
Backpack : Tunnel M  
**Craftsmangus : Pattern**  
(if 2 layers) / 3.0-3.5 mm. if 1 layer.

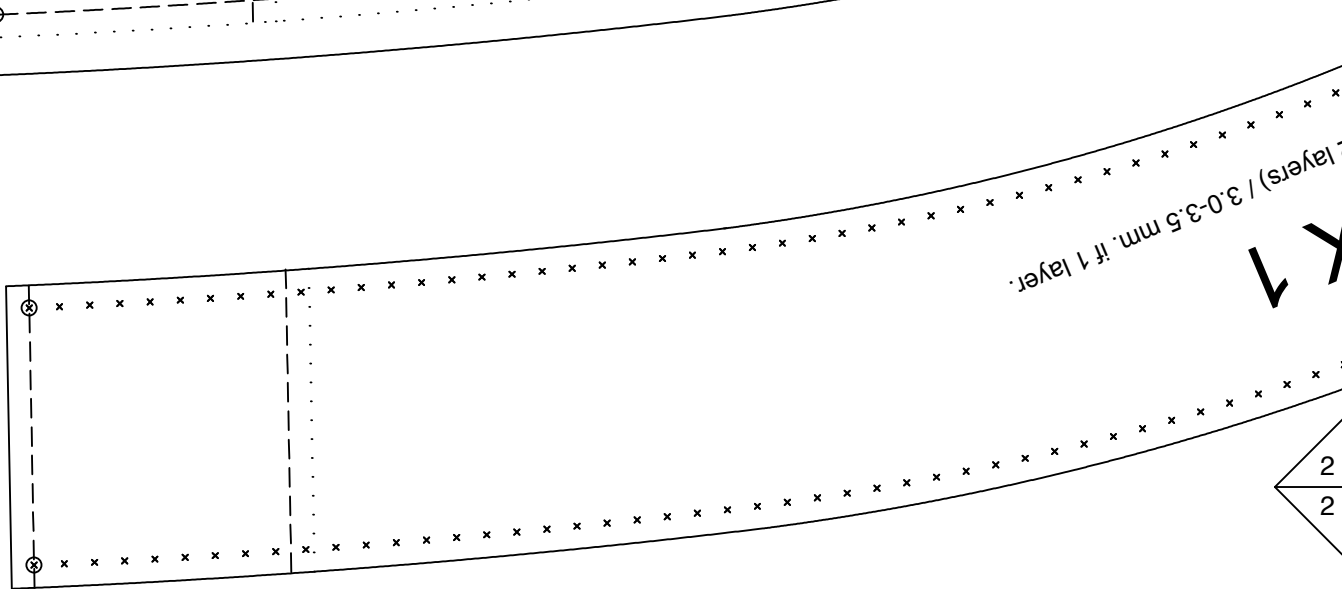
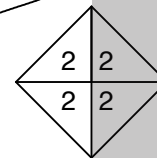

1.5 mm. Leather Recommended (if 2 layers) / 3.0-3.5 mm. if 1 layer.  
Top Backpack Strap (Left)  
BP TU-01 #4mm.  
Backpack : Tunnel M  
**Craftsmangus : Pattern**

TILE TO PAGE 16





TILE TO PAGE 15

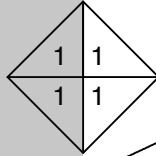

**Craftsmangus : Pattern X 1**  
Backpack : Tunnel M  
BP TU-01 #4mm.  
Backpack Strap Recommended (if 2 layers) / 3.0-3.5 mm. if 1 layer.  
Then no cut this if 1 Leather Layer  
Back Backpack Layer

X 1

X 1

**Craftsmangus : Pattern X 1**  
Backpack : Tunnel M  
BP TU-01 #4mm.  
Backpack Strap Recommended (if 2 layers) / 3.0-3.5 mm. if 1 layer.  
1.5 mm. Leather Recommended (Left)

